

# SONY

VPL-VW760ES 4K Home Cinema projector

At a glance

- 4K resolution: 4096 x 2160
- High brightness 2,000 ANSI lumens
- Up to 20,000 hours virtually maintenance-free laser technology.\*
- Exceptional dynamic contrast
- Futureproofed with support for latest picture standards
- Auto calibration

Key Features

### Shaped by our professional cinema expertise

There's decades of Sony experience in developing technology for the big screen packed into all our home cinema projectors:

#### 4K native resolution

Enjoy uncompromised 4K images, with no artificial pixel enhancement.

#### True 4K HDR

High Dynamic Range takes you closer still to reality with higher contrast, richer colours and a wider range of brightness levels from deep, dark blacks to bright, sparkling highlights.

#### Reality Creation

Enjoy your existing Full HD Blu-ray™ collection, upscaled for an exceptional 4K experience – even in 3D.

#### Easy to control

Compatible with Crestron Connected and Control 4 SDDP for easy control and enhanced home automation capability.



## VPL-VW760ES Home Cinema entertainment at its very finest

### Discover all the emotion of cinematic entertainment in true 4K HDR

Experience the cinema-quality entertainment you've always dreamed of. The beautifully styled VPL-VW760ES represents a new landmark in home cinema technology, achieving extraordinary levels of picture performance that you'd expect from a bigger, more costly projector.

The long-lasting laser light source delivers a powerful 2,000 lumen output for exceptional images, even in larger home cinema rooms and well-lit living spaces. Laser light levels are precisely controlled in real time, assuring truly spectacular dynamic contrast range with the latest 4K HDR content.

### Enjoy all your content in 4K

While more native 4K material is becoming available, the VPL-VW760ES uses Reality Creation technology that upscales Full HD content for an incredible 4K experience. You'll get the best from your current Blu-ray Disc™ library and video streaming services – with extraordinary clarity, colour and contrast.

### Easy to install and use

Remarkably compact and elegantly styled, the VPL-VW760ES is beautifully easy to operate with a choice of picture modes for outstanding results with any content. With generous connections and interfaces, it also offers great flexibility for smooth integration in any AV entertainment set-up.

SXR

4K

TRILUMINOS  
DISPLAY



### 4K native resolution: over four times more detail than Full HD

Don't compromise with true 4K (4096 x 2160 pixel) resolution, the standard used in the digital cinema industry. You'll find the same SXRD panel technology used in our professional projectors, producing 4K native pictures with no artificial pixel enhancement. ▼

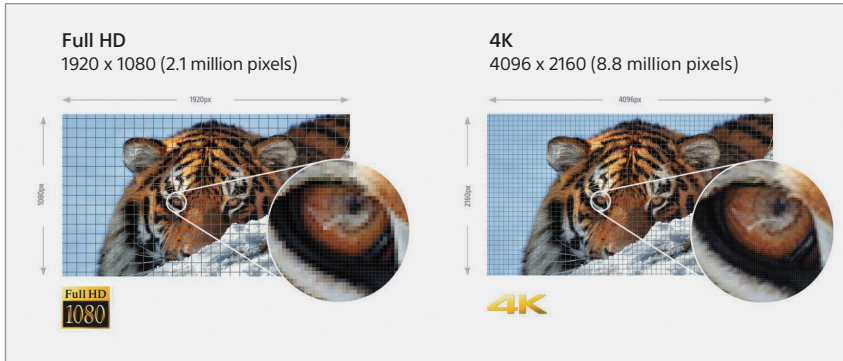

Simulated images

### Advanced 4K SXRD Panels

The VPL-VW760ES automatically adjusts contrast for optimum picture quality by analysing dark and light areas in every scene. Advanced SXRD panel technology features a highly reflective liquid crystal layer and an alignment layer without bevelled corners or contact divots, enabling an ultra-fast response rate of just 2.5 milliseconds. Space is minimised between adjacent pixels for dot-free pictures with deep contrast. ▼

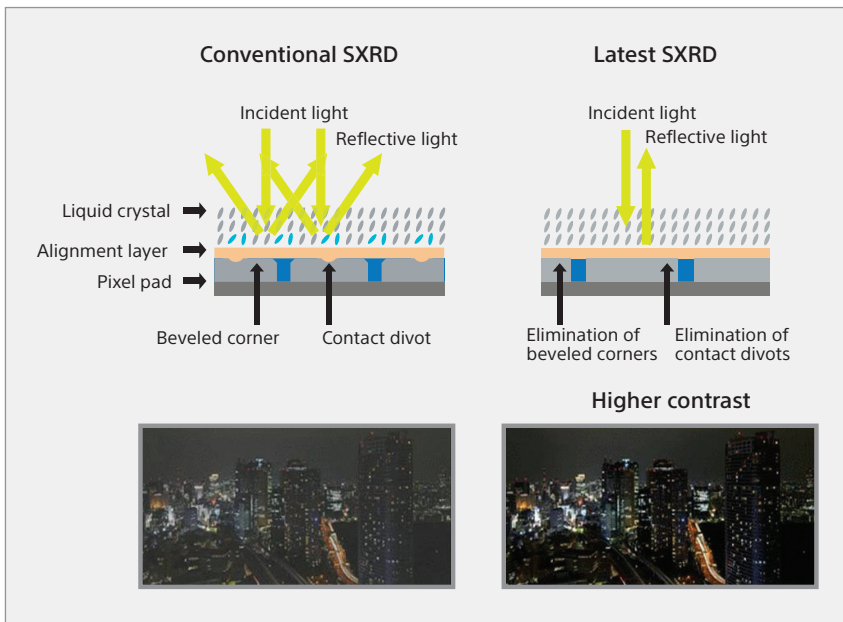

Simulated images

### Motionflow for smoother, more natural images

The VPL-VW760ES uses Motionflow technology to insert additional picture frames, in both Full HD and 4K, reducing blur in fast-paced action scenes. Combination mode creates additional dark frames to reduce blur for more natural motion. Great for movie purists, True Cinema mode maintains the original 24p frame rate. ▼

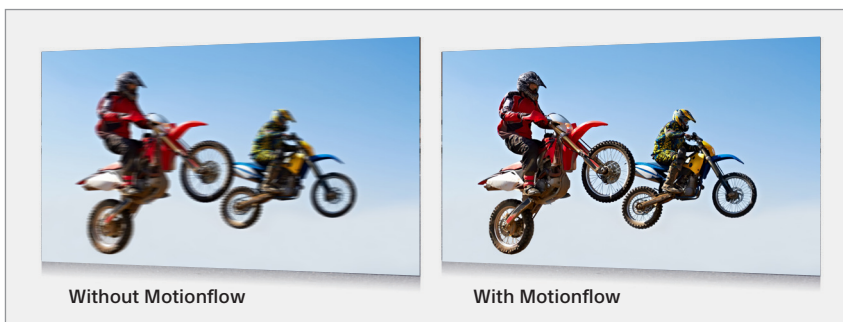

Simulated images

### Compatible with High Dynamic Range (HDR10, HLG)

Enjoy movies and streaming services in 4K HDR with a far wider range of brightness levels, from sparkling highlights to rich, deep blacks. Whatever you're watching, you'll enjoy a more lifelike entertainment experience with extremely high contrast, exquisite colour and fine detail.

### Extremely high dynamic contrast

Laser light levels are precisely controlled in real time, achieving an exceptionally high dynamic contrast ratio of ∞:1. Fine shadow detail is revealed in dark scenes, without compromising reproduction of bright scenes for truly captivating images.

### Low latency mode

Great for gamers, low latency mode minimises input lag for speedy on-screen responses, even when you're playing the latest 4K titles.

### Support for latest picture standards

The VPL-VW760ES can project 4K content at up to 60 frames per second, the latest 4K industry standard that's much higher than the earlier 24p. The result is smoother, more realistic images, especially with fast-paced action. And with support for HDCP 2.2, you're future-proofed to make the most of today's premium 4K releases – and tomorrow's.

### Rear fan exhaust

Air intakes at the front of the projector are matched by a rear air exhaust for the low-noise fan, ensuring optimum picture quality.

### Industry standard RF 3D compatible

A built-in RF transmitter synchronises with any RF 3D glasses for wider coverage, greater stability, and there's no need for an external transmitter. ▶



Sony RF 3D Glasses

### Reality Creation: upscales your movies to 4K

As well as native 4K material, you can see your current Full HD Blu-ray™ or DVD movie collection upscaled for a 4K experience. Reality Creation is a technology that radically enhances Full HD content, even upscaling 3D movies for 4K. ▼

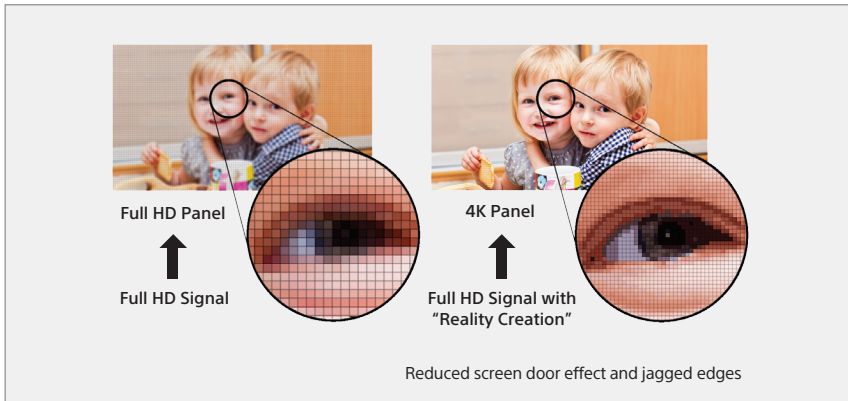

Simulated images

### Compatible with 4K Ultra HD Blu-ray™ discs

Enjoy 'Mastered in 4K' Blu-ray Discs upscaled from 2K to 4K pixel resolution, faithfully reproducing the detail and colour range of the original 4K master. ▼

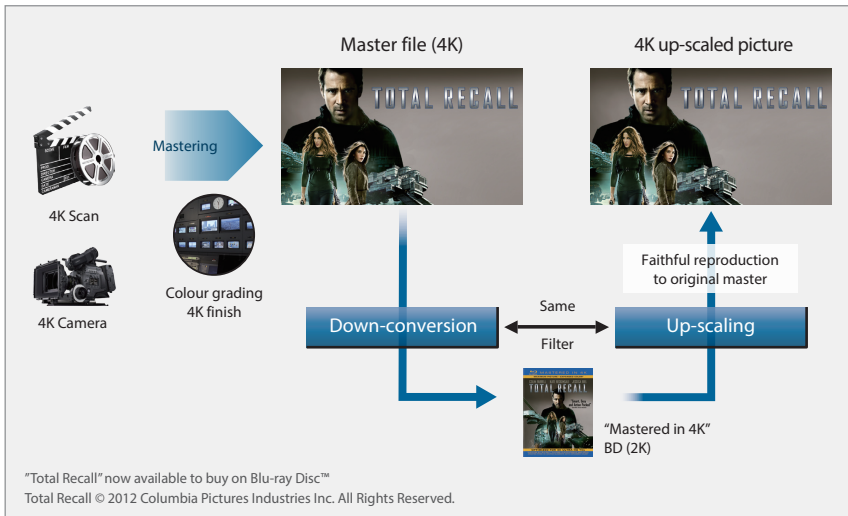

"Total Recall" now available to buy on Blu-ray Disc™  
Total Recall © 2012 Columbia Pictures Industries Inc. All Rights Reserved.

Simulated images

### Wider zoom and shift lens

A 2.06 motorised zoom lens and wide lens shift range of up to 85% vertical and 31% horizontal gives greater installation flexibility – even when the ceiling is very high.

### Suitable for home automation

The VPL-VW760ES is compatible with many home automation systems, including Crestron Connected and Control4 SDDP. It offers an RS232 interface, RJ45 control and IR-IN terminal.

### Manual Colour Correction

Precisely adjust gamma plus hue, saturation and brightness for each colour to create exactly the picture you want.

### TRILUMINOS™ Display

Sony's advanced TRILUMINOS™ Display technology reproduces a much broader colour range, reproducing more tones and textures than standard projectors. You'll see the difference with greater colour purity, depth and realism in every scene.

### Auto Calibration

After extended operating periods, colour can be automatically calibrated to match the original factory settings. There's no need for special calibration equipment: you'll enjoy consistent colours with every performance.



### HDCP 2.2 compatible

The VPL-VW760ES is ready for premium 4K content, including TV, internet streamed productions and satellite broadcasts. ▼



Sony UBP-X1000ES 4K Blu-ray player

### Sit closer

With 4K resolution, you can sit closer to the screen without compromising depth and realism. The best viewing position for 4K is at a distance of approximately 1.5 times the height of the projector screen (PH), compared to 3 times the height of the screen for Full HD. ▼

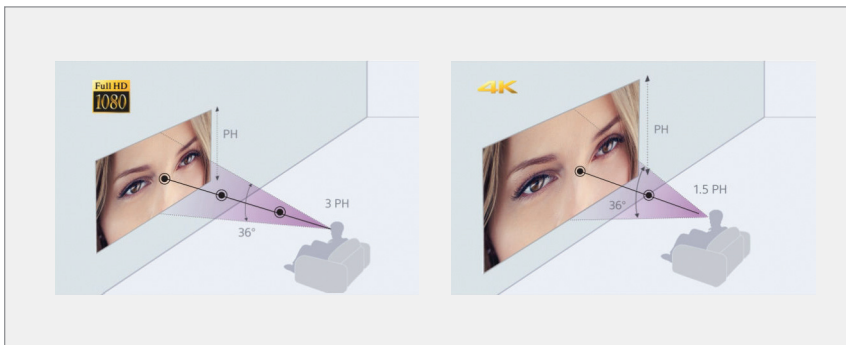

Simulated images

### Electronic panel alignment

Ensures the red and blue elements in each pixel are precisely positioned against green. Adjustments can be made by as little as 0.1 pixels for optimum clarity. (NB we recommend adjustments are made when the projector is warm). ▼

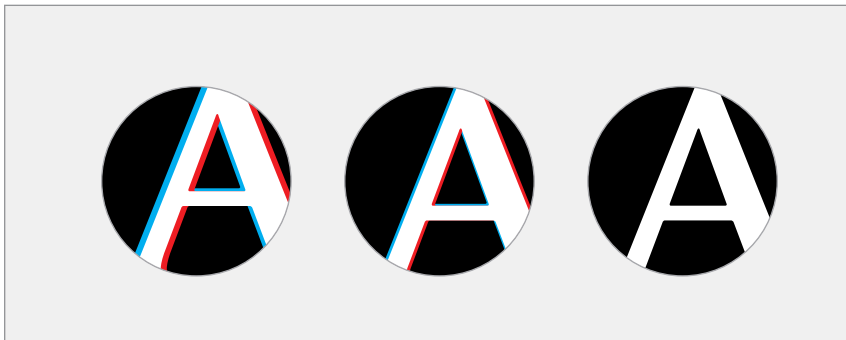

Simulated images

### Wireless option (up to Full HD 60p)

Free yourself from cables and keep things tidy with an optional wireless HDMI emitter/receiver kit. The VPL-VW760ES can wirelessly connect to your games console, Blu-ray™ Disc player and more, and upscales for a 4K experience with Reality Creation.

### USB updates

To get the best from your projector, the VPL-VW760ES has USB ports to automatically receive the latest firmware updates, directly to the projector.

### Long lasting laser light source

The projector's efficient, long-lasting laser light source offers up to 20,000 hours\* virtually maintenance-free operation, with minimal drop-off in image brightness over the laser's long operating life.

*\*Actual hours may depend on usage and operating conditions.*

### Quick turn On/Off

The laser projector can be turned on and off quickly.

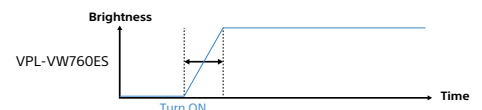
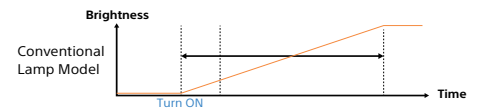

### Optional Accessories



TDG-BT500A  
3D Glasses

### Projection distance

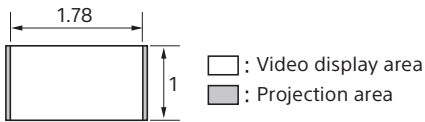

1.78:1 (16:9)		
Projection image size		Projection distance L
Diagonal	Width × Height	
80" (2.03 m)	1.77 × 1.00 (70 × 39)	2.44 - 5.01 (96 - 197)
100" (2.54 m)	2.21 × 1.25 (87 × 49)	3.05 - 6.28 (121 - 247)
120" (3.05 m)	2.66 × 1.49 (105 × 59)	3.67 - 7.55 (145 - 297)
150" (3.81 m)	3.32 × 1.87 (131 × 74)	4.60 - 9.44 (181 - 371)
200" (5.08 m)	4.43 × 2.49 (174 × 98)	6.15 - 12.61 (242 - 496)

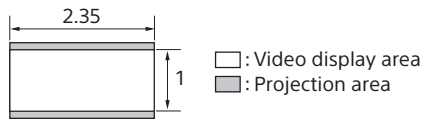

2.35:1		
Projection image size		Projection distance L
Diagonal	Width × Height	
80" (2.03 m)	1.87 × 0.80 (74 × 31)	2.41 - 4.96 (95 - 195)
100" (2.54 m)	2.34 × 0.99 (92 × 39)	3.02 - 6.22 (119 - 244)
120" (3.05 m)	2.80 × 1.19 (110 × 47)	3.64 - 7.47 (143 - 294)
150" (3.81 m)	3.51 × 1.49 (138 × 59)	4.55 - 9.35 (180 - 368)
200" (5.08 m)	4.67 × 1.99 (184 × 78)	6.08 - 12.48 (240 - 491)

### Connector Panel

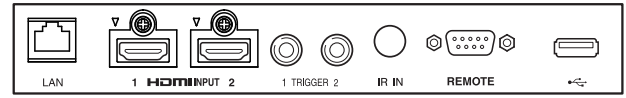

### Dimensions

Units: mm (inches)

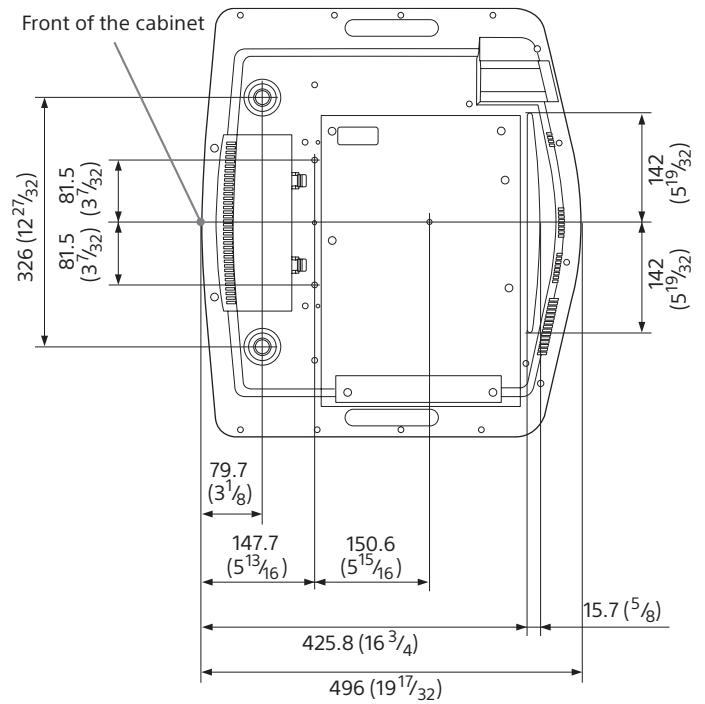
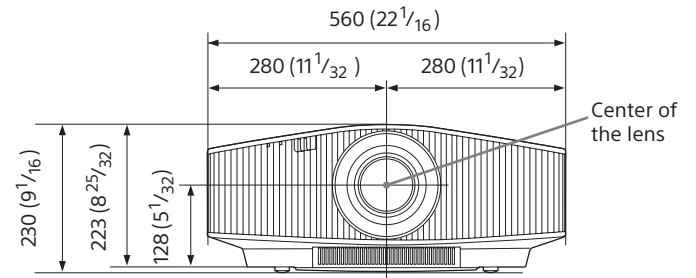

## Specifications

Display System		4K SXRD panel, projection system
Display device	Size of effective display area	0.74" x 3
	Number of pixels	26,542,080 (4096 x 2160 x 3) pixels
Projection lens	Focus	Powered
	Zoom	Powered (Approx. x 2.06)
	Lens shift	Powered Vertical: +85% -80% Horizontal: +/-31%
Light source		Laser diode
Screen size		60" to 300" (1,524 mm to 7,620 mm)
Light output		2000 lm
Color light output		2000 lm
Dynamic contrast		∞:1
Displayable scanning frequency	Horizontal	19 kHz to 72 kHz
	Vertical	48 Hz to 92 Hz
Display resolution*1	Computer signal input	Maximum display resolution: 1920 x 1080 dots (HDMI Input only)
	Video signal input	480/60p, 576/50p, 720/60p, 720/50p, 1080/60i, 1080/50i, 1080/60p, 1080/50p, 1080/24p, 3840 x 2160/24p, 3840 x 2160/25p, 3840 x 2160/30p, 3840 x 2160/50p, 3840 x 2160/60p, 4096 x 2160/24p, 4096 x 2160/25p, 4096 x 2160/30p, 4096 x 2160/50p, 4096 x 2160/60p
OSD language		18-languages (English, Dutch, French, Italian, German, Spanish, Portuguese, Turkish, Polish, Russian, Swedish, Norwegian, Japanese, Simplified Chinese, Traditional Chinese, Korean, Thai, Arabic)
INPUT OUTPUT (Computer / Video / Control)	HDMI1 / HDMI2*2	Digital (RGB/Y Pb/Cb Pr/Cr)
	Trigger1 / Trigger2	Minijack, DC 12 V Max. 100 mA
	Remote	RS-232C, D-sub 9-pin (male)
	LAN	RJ45, 10Base-T/100BASE-TX
	IR IN	Mini Jack
	USB	DC 5V, Max. 500 mA
Acoustic noise		24 dB*3
Operating temperature / Operating humidity		5°C to 35°C (41°F to 95°F) / 35% to 85% (no condensation)
Storage temperature / Storage humidity		-20°C to +60°C (-4°F to +140°F) / 10% to 90% (no condensation)
Power requirements		AC 100 V to 240 V, 4.3 A to 1.8 A, 50/60Hz
Power consumption		430 W
	Standby	0.4 W (when "Remote Start" is set to "Off")
	Networked Standby	1.0 W (LAN) (when "Remote Start" is set to "On") When a LAN terminal is not connected, it becomes a low power consumption mode (0.5 W).
Dimensions (W x H x D) (without protrusions)		560 x 223 x 496 mm 22 1/16 x 8 25/32 x 19 17/32 inches
Mass		Approx. 20 kg / 44 lb
Supplied accessories		RM-PJ24 Remote Commander (1), Size AA (R6) Manganese Batteries (2), Lens Cap (1), AC Power Cord (1), Operating Instructions (CD-ROM) (1), Quick Reference Manual (1), Safety Regulations (1)

\*1 Displayed image may be converted for some input signals.

\*2 Both HDMI inputs are compatible with HDCP2.2

\*3 This value is approximate. Depends on the projector setting condition and usage environment.

### LASER NOTICES

For the U.S.A.

IEC 60825-1:2007 CLASS 3R LASER PRODUCT



For other countries

IEC 60825-1:2014 CLASS 1 LASER PRODUCT

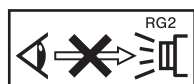

As with any bright light source,  
do not stare into the beam,  
RG2 IEC 62471-5:2015.

PrimeSupport  
Pro

Distributed by

©2017 Sony Imaging Products & Solutions Inc. Reproduction in whole or in part without written permission is prohibited. Features and specifications are subject to change without notice. The values for mass and dimension are approximate. "SONY" is a registered trademark of Sony Corporation. "3D World", "TRILUMINOS", "Z-Phosphor", "SXRD" and "Remote Commander" are trademarks of Sony Corporation. The terms HDMI and HDMI High-Definition Multimedia Interface, and the HDMI Logo are trademarks or registered trademarks of HDMI Licensing LLC in the United States and other countries. All other trademarks are the property of their respective owners. Please visit Sony's professional website or contact your Sony representative for specific models available in your region.

**SONY**