



# The Best Choice for Meeting Rooms and Classrooms

- 3200AL Brightness and exceptional 13000:1 contrast ratio
- Large choice of input connections (HDMI, 2xVGA IN, VGA OUT...)
- 3D ready
- LAN control
- Dust filter free design
- Energy saving: SmartEco, auto power off, Eco blank, 0.5W standby power consumption\*
- Lamp life time up to 10000 hours\*\*
- 6 segment color wheel for better color reproduction
- 10W speaker with powerful sound
- Low operation noise (28dBA)\*\*\*

\* Network off

\*\* In LampSave mode

\*\*\* In eco mode



MX570 3200AL XGA DLP Projector  
 MW571 3200AL WXGA DLP Projector



Because it matters

# Exceptional Image Quality for High-Impact Presentations

## Superior Image Quality

With 3200 ANSI lumens high brightness, the MX570/MW571 will always give you the best clarity under the brightest lights! So, take advantage! Stay in control and enjoy perfect presentations and the best interactions with your audience; moreover, the combined expertise of BenQ's projector know-how delivers an astounding 13000:1 contrast at the highest to significantly improve the black level for superbly rendered image definition.



High Contrast

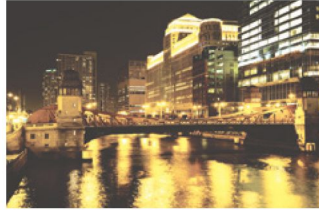

Low Contrast

## Long-Lasting DLP Image Perfection

Utilizing a nearly-sealed DLP projection engine, BenQ projectors exhibit virtually no image distortion from panel aging due to heat or dust buildup. Millions of micro mirrors on the advanced DMD chip reflect pure light through the color wheel, producing precise details and intensely saturated colors without degradation over time.

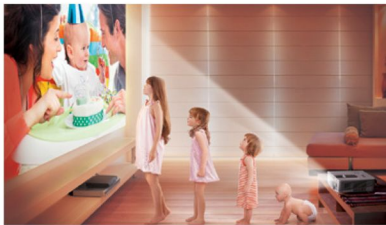

## Perfect Six-Color Management via Independent 3D Calibration

Independently fine-tune the hue, gain, and saturation levels of each of the six primary colors (R/G/B/C/M/Y) with innovative BenQ 3D color management. The ability to precisely control these parameters greatly enhances mid-tones and greyscales to deliver more realistic images and video.



## Blu-ray Full HD 3D Supported

BenQ MX570/MW571 is built with latest DLP® technology to support 3D functionality, allowing schools to bring an immersive learning experience to their students with a simple preparation of 3D glasses and 3D content from your Blu-ray player.



## LampSave Mode: Save More

Less lamp replacements and maintenance translates into an overall lower cost of ownership. The LampSave Mode does exactly that by adjusting the lamp power dynamically by content level to extend projector lamp life significantly by up to 50% as compared to normal mode.

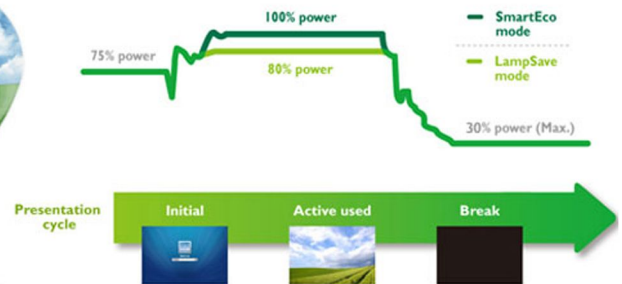
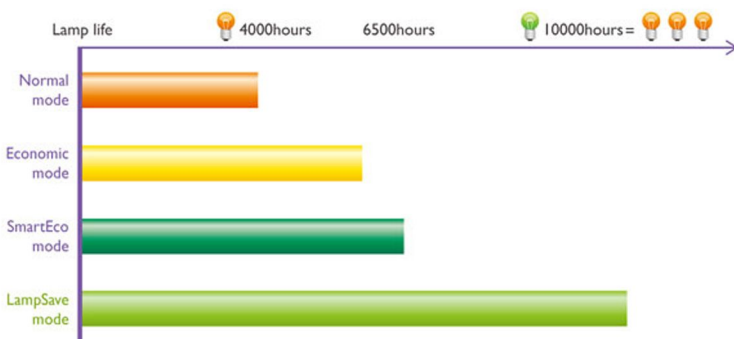

## Installation Flexibility

BenQ MX570 XGA projector can offer more installation flexibility with bigger zoom ratio.

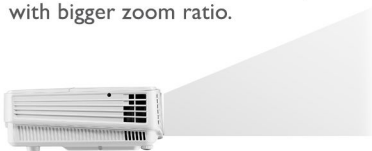

BenQ MX570 1.51~1.97 : 1

Average 3LCD 1.5~1.8 : 1

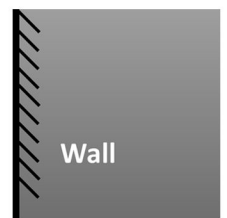

Wall



# Complete Remote Control and Easy Maintenance

## LAN-Based Multiple Projector Management (AMX/CRESTRON/PJ-Link/Extron)

Projector monitoring, scheduling, and management are under convenient IT manager control utilizing BenQ's intuitive interface. Compatible with PJ-Link, Crestron, and AMX control systems for convenient system integration with multiple third-party A/V components, BenQ High Brightness projectors allow remote operation and status supervision over multiple remote projectors to minimize labor cost and resources.



## Dust Filter Free Design

BenQ Projectors feature leading-edge Digital Light Processing (DLP) Technology, featuring nearly-sealed projection engines able to deliver persistent picture perfection without the hassles and costs of filters. The ability of DLP to keep heat and dust out of the engine results in long-lasting clarity without unnecessary filter replacement and cost.



Dust filter free



No dust filter to change or clean



Save your money!

## World-Leading SmartEco™ Technology for a Greener Environment

As the first DLP brand to incorporate Philips' ImageCare technology into its projector lamp system, BenQ has taken a further leap, developing its own SmartEco™ Technology to perfect what DLP can do for energy saving in any occasion. Built with this brand new invention, the BenQ projector brings together uncompromised brightness innovative features.



## Convenient Lamp Access

Top-mounted quick-release doors for lamp replacement eliminate the need to move the projector for quick, hassle-free lamp exchange. This versatility prevents the need to remove the projector from its mounting bracket in single or multiple projector installations for lamp replacement.

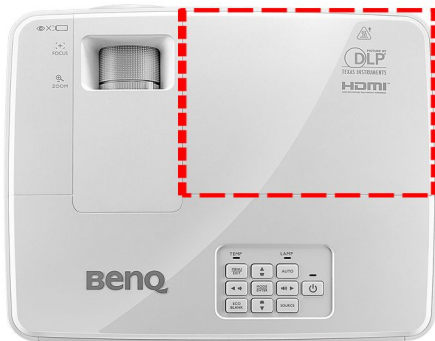

## Eco Blank Mode

During breaks in presentations or when the projector is not in use, Eco Blank Mode reduces power consumption by up to 70% while at the same time eliminating distractions from the inactive screen. The blanked screen refocuses the audience's attention to the presenter while conserving energy.



Full Power On  
(100% Lamp Power)



Eco Blank Mode On  
(30% Lamp Power at the Lowest)

# Unique Features for Classrooms

## Built-in 10W Big Audio Power

The MX570/MW571 feature built-in 10W speakers to help enrich every lesson with top quality audio performances. These speakers are sealed and secured within the projector housing by BenQ's anti-shake design to ensure projection stability at all times.



## Microphone Input Support

With the microphone input, teachers get to reach every student with straining their voice. All they need to do is plug in the microphone or microphone headset to get started!



## Thoughtful Teaching Template Design

To make your teaching job easier, BenQ has added the teaching template function to the MX570/MW571. Now, with three different line pattern designs to choose from – Letter Formation, Worksheet and Coordinate Chart, you can easily write or draw on whiteboards as well as blackboards without the need of drawing lines or charts.

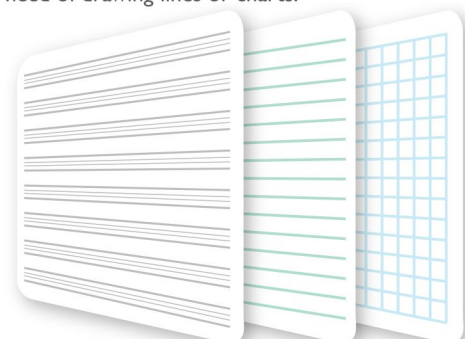

## Dimensions

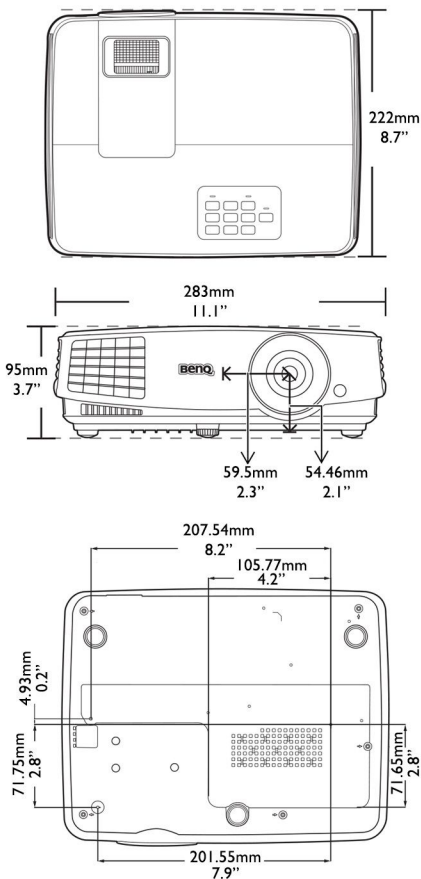

## Specifications

	MX570	MW571
<b>Projection System</b>	DLP™	DLP™
<b>Color Wheel</b>	6 seg (RGBCYW)	6 seg (RGBCYW)
<b>Native Resolution</b>	XGA (1024x768)	WXGA (1280x800)
<b>Brightness</b>	3200 ANSI Lumens	
<b>Contrast Ratio</b>	13000:1	
<b>Display Color</b>	1.07 Billion Colors	
<b>Lens</b>	F= 2.59~2.87, f= 16.88~21.88mm	
<b>Aspect Ratio</b>	4:3	16:10
<b>Throw Ratio</b>	1.51-1.97:1	1.21-1.57:1
<b>Max. Image Size (Diagonal)</b>	300"	
<b>Zoom Ratio</b>	x1.3	
<b>Lamp Wattage</b>	190W	196W
<b>Lamp(Normal/Eco Mode/SmartEco/LampSave Mode)</b>	4000h/6000h/6500h/10000h	
<b>Keystone Adjustment</b>	V: +/-40°	
<b>Projection Offset</b>	115%±5%	120%±5%
<b>PC Signal Compatibility</b>	up to UXGA (1600x1200)	
<b>HDTV Compatibility</b>	480i, 480p, 576i, 576p, 720p, 1080i, 1080p	
<b>Video Compatibility</b>	NTSC, PAL, SECAM	
<b>Horizontal Frequency</b>	15~102KHz	
<b>Dimensions(W x H x D)</b>	283mm x 222mm x 95mm	
<b>Weight</b>	1.9kg	
<b>Audible Noise (normal/eco)</b>	33/28dBA	
<b>Power Supply</b>	AC 100 to 240 V, 50/60 Hz	
<b>Power Consumption (typical)</b>	280W	
<b>Standby power consumption</b>	<0.5W (network off)	
<b>Operating environment</b>	0~40°C / 10%~90% humidity w/ no condensation	

### What's in the box

remote control w/ battery, power cord, user manual CD, quick start guide, warranty card, VGA cable

\*Lamp life results will vary depending on environmental conditions and usage. Actual product's features and specifications are subject to change without notice.

## Input and Output Terminals

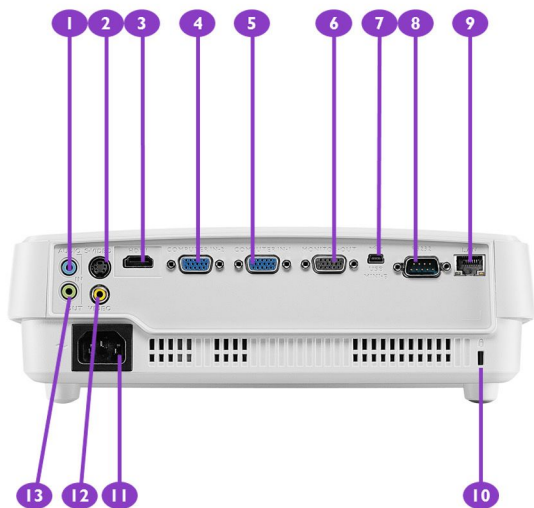

1. Audio input RGB
2. S-Video input
3. HDMI input
4. RGB2 input
5. RGBI/YUV input
6. RGB signal output
7. USB Mini - B type port
8. RS-232 control port
9. RJ45 LAN input (control)
10. Kensington anti-theft lock
11. AC power cord inlet
12. Video input
13. Variable audio output

## Key Features

- Filter free design
- Compatible with PLink
- Compatible with Crestron
- Compatible with AMX
- Compatible with Extron
- Auto power off
- VGA signal power on
- Direct power on/off
- Supports all 3D mandatory formats
- Standby power <0.5W (network off)
- SmartEco energy saving
- Eco Blank mode
- 2X digital zoom
- Quick auto source search
- Closed captioning
- Panel key lock
- Kensington lock
- Variable audio out
- Top access lamp door

## Optional accessory

- Spare Lamp Kit** - 5J.J9R05.001
- Universal Ceiling Mount** - CM00G3 (5J.JAM10.001)



- Active 3D glasses** - DGD5 (5J.J9H25.001)

- Carry bag** - (5J.J3T09.001)



- Presenter** - PSR1 (5J.JAG27.01E)

- QCast dongle** - QP01 (5J.JCK28.E01)



## BenQ Europe B.V.

Meerenakkerweg 1-17  
5652 AR Eindhoven  
The Netherlands  
Tel: +31 88 888 9200  
Fax: +31 88 888 9299



Because it matters