



Dual Lamp HDBaseT Projector with Great Setup Flexibility

- High Brightness 6500AL and remarkable contrast ratio 8300:1 and WUXGA resolution
- Big zoom ratio, horizontal and vertical lens shift provides flexible installation
- HDBaseT makes the installation simple and affordable, transmit video/audio/control signal by a single CAT5e cable (or higher)
- Easy asset management via LAN control
- Easy setup: Vertical and Horizontal keystone adjustment, Corner fit, Auto input signal search, VGA signal power on, Dual HDMI inputs
- Easy maintenance: Dust filter free design, Top access lamp door for easy lamp change
- Energy saving and environmental friendly: SmartEco, Eco blank, less than 0.5W standby power consumption (Network off), Sleep timer, Auto power off



BenQ SU964 6500AL
WUXGA DLP Projector



Because it matters

Exceptional Image Quality for High-Impact Presentations

Superior Image Quality

With 6500 ANSI lumen high brightness, the SU964 will always give you the best clarity under the brightest lights! So, take advantage! Stay in control and enjoy perfect presentations and the best interactions with your audience; moreover, the combined expertise of BenQ's projector know-how delivers an astounding 8300:1 contrast at the highest to significantly improve the black level for superbly rendered image definition.



High Contrast



Low Contrast

Brilliant Image Performance Ultra High Resolution up to WUXGA

With up to 2.3 million pixels of resolution far surpassing 1080p, audiences can view even high-quality Full HD content in breathtaking clarity, and presenters can show more content and detail without sacrificing legibility. High resolution brings out fine details and produces more lifelike three-dimensional appearance for pictures while resolving even small text with crisp precision.

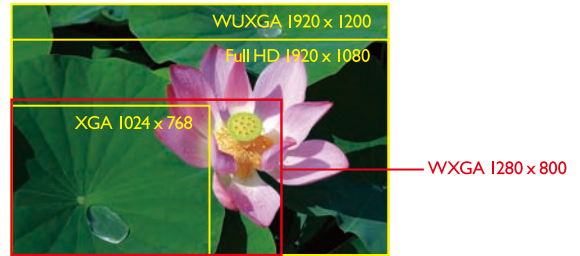

Long-Lasting DLP Image Perfection

Utilizing a nearly-sealed DLP projection engine, BenQ projectors exhibit virtually no image distortion from panel aging due to heat or dust buildup. Millions of micro mirrors on the advanced DMD chip reflect pure light through the color wheel, producing precise details and intensely saturated colors without degradation over time.

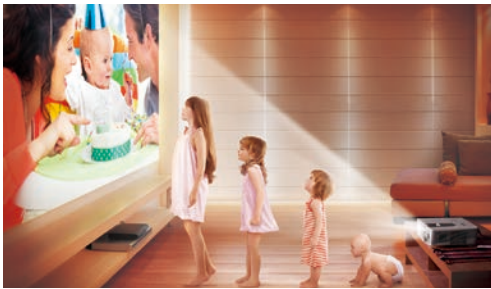

Perfect Six-Color Management via Independent 3D Calibration

Independently fine-tune the hue, gain, and saturation levels of each of the six primary colors (R/G/B/C/M/Y) with innovative BenQ 3D color management. The ability to precisely control these parameters greatly enhances mid-tones and greyscales to deliver more realistic images and video.



Installation Flexibility

Lens Shift for Extra Room for Minor Miscalculations

Lens shift offers the extra flexibility to overcome any minor miscalculations during projector installation. All you have to do is adjust the switch next to the lens to shift the projected image left or right by 15% or up or down by 45% within the projector housing. With this helpful feature, you'll never have to worry about positioning the projector slightly out of place again!

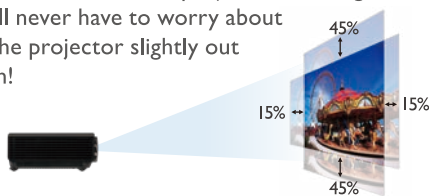

Big Zoom for Extra Projector Installation Flexibility

SU964 1.5x big zoom feature opens up space with an impressively wide range of throw distances. All you have to do is simply place the new projector right where your original ceiling mount is. Without adding projector setting re-construction costs to your budget list, you'll get to save the money for better use.



2D Keystone Correction & Corner Fit Correction

When the projector is placed off-center, the 2D keystone correction feature gives you a wider projector installation flexibility by correcting the trapezoid effect using horizontal and vertical adjustments. Moreover, corner fit is a flexible and convenient way to correct picture dimensions by adjusting each corner of an image independently.

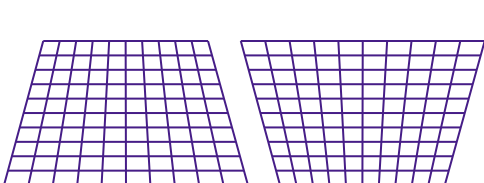

Vertical Keystone

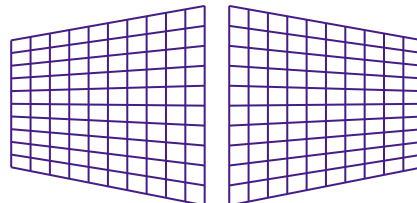

Horizontal Keystone

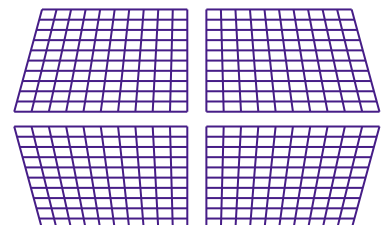

Corner Fit

Complete Remote Control and Easy Maintenance

LAN-Based Multiple Projector Management (AMX / CRESTRON / PJLink / Extron)

Projector monitoring, scheduling, and management are under convenient IT manager control utilizing BenQ's intuitive interface. Compatible with PJLink, Crestron, and AMX control systems for convenient system integration with multiple third-party A/V components, BenQ High Brightness projectors allow remote operation and status supervision over multiple remote projectors to minimize labor cost and resources.

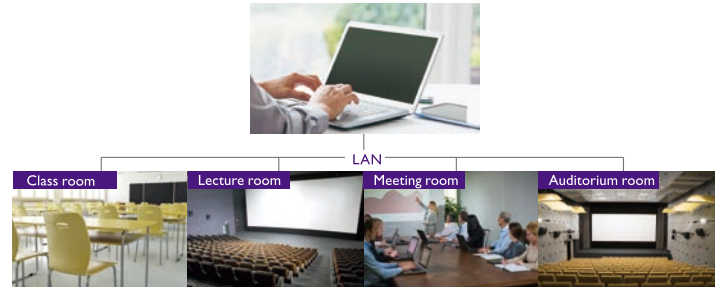

Dust Filter Free Design

BenQ Projectors feature leading-edge Digital Light Processing (DLP) Technology, featuring nearly-sealed projection engines able to deliver persistent picture perfection without the hassles and costs of filters. The ability of DLP to keep heat and dust out of the engine results in long-lasting clarity without unnecessary filter replacement and cost.



World-Leading SmartEco™ Technology for a Greener Environment

As the first DLP brand to incorporate Philips' ImageCare technology into its projector lamp system, BenQ has taken a further leap, developing its own SmartEco™ Technology to perfect what DLP can do for energy saving in any occasion. Built with this brand new invention, the BenQ projector brings together uncompromised brightness innovative features.



Convenient Lamp Access

Top-mounted quick-release doors for lamp replacement eliminate the need to move the projector for quick, hassle-free lamp exchange. This versatility prevents the need to remove the projector from its mounting bracket in single or multiple projector installations for lamp replacement.



Eco Blank Mode

During breaks in presentations or when the projector is not in use, Eco Blank Mode reduces power consumption by up to 70% while at the same time eliminating distractions from the inactive screen. The blanked screen refocuses the audience's attention to the presenter while conserving energy.



Connectivity

Advanced Connectivity

• 2x HDMI

· It allows for simultaneous digital connection of high-definition A/V devices

• HDBaseT Advanced Digital Connectivity

· It combines video, audio and control signals from multiple HDMI sources onto a single CAT5e (or higher), capable of lossless transmissions up to 100 meters. This incredibly efficient and cost-effective connectivity is also ideal for ceiling-mounted and other permanent installations.

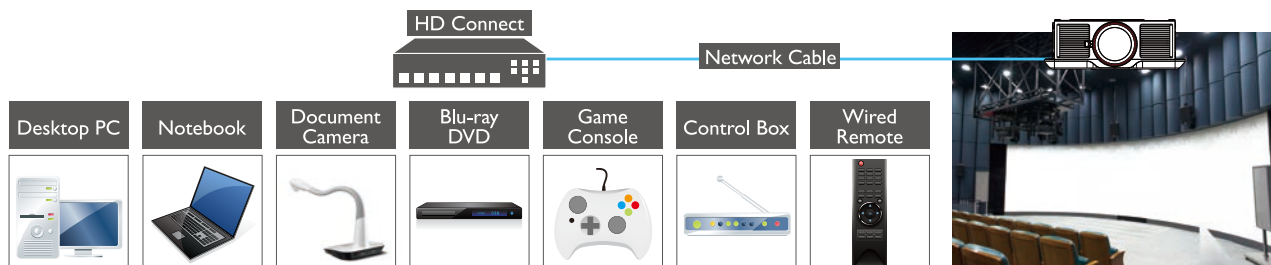

Dimension

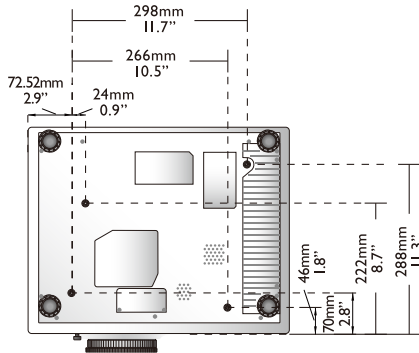
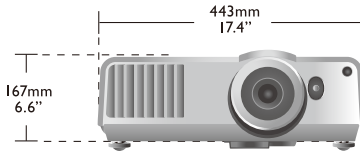
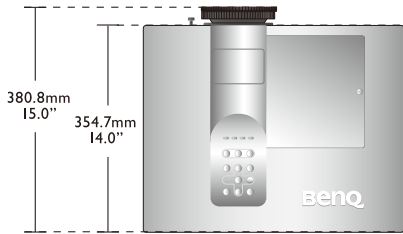

Specification

Projection System	DLP
Native Resolution	WUXGA (1920x1200)
Brightness*	6,500 ANSI Lumens
Contrast Ratio	8,300:1
Display Color	1.07 Billion Colors
Lens	F=2.48~2.81, f=24.10~36.15mm
Aspect Ratio	Native 16:10 (5 aspect ratios selectable)
Throw Ratio	1.62 - 2.43
Image Size (Diagonal)	70" ~ 300"
Zoom Ratio	1.5x
Lamp Type	350W x2
Lamp (Normal/Economic Mode)*	2000/2500 hours
Keystone Adjustment	Vertical & Horizontal ± 30 degrees
Lens shift range	Vertical: ±45%, Horizontal: ±15%
PC Signal Compatibility	VGA (640 x 480) to WUXGA_RB (1920 x 1200) *RB = Reduced blanking
HDTV Compatibility	480i, 480p, 576i, 576p, 720p, 1080i, 1080p
Video Compatibility	NTSC, PAL, SECAM
Dimensions (W x H x D)	443 x 167 x 354.7mm (17.4 x 6.6 x 13.9 inches)
Weight	13 Kg (8.16 lbs)
Audible Noise	44 / 40 / 41 / 38 db (Normal Dual / Eco Dual / Normal Single Alternative / Economic Single Alternative)
Power Supply	AC100 to 240V, 50 to 60 Hz
Power Consumption	940W (Dual lamp normal mode) 770W (Dual lamp eco mode) 490W (Single lamp)
Operating environment	Operating temperature 0°C-40°C Operating humidity 10%-90% (no condensation)

*Lamp life results will vary depending on environmental conditions and usage. Actual product's features and specifications are subject to change without notice.

Input and Output Terminals

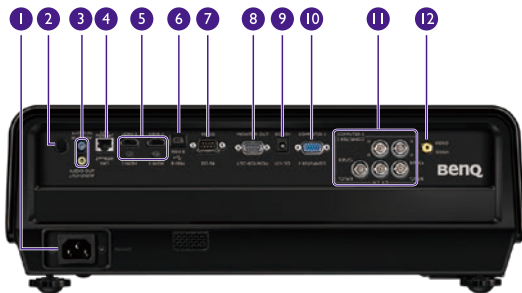

- 1 AC Power cable inlet
- 2 Rear IR sensor
- 3 Audio input jack / Audio output jack
- 4 RJ45 LAN / HDBaseT input jack
- 5 HDMI port
- 6 Mini B type USB port
- 7 RS-232 control port
- 8 RGB signal output jack
- 9 12V DC output terminal
- 10 RGB (PC) / Component video (YPbPr/YCbCr) signal input jack
- 11 Component Video inputs (BNC) / RGBHV 5 BNCs for connecting either RGB or component (YPbPr), SD or HD video signals
- 12 Video input jack

Optional accessory

Universal ceiling mount
- CM00G3 (5J,JAM10.001)



QCast dongle
- QP01 (5J,JCK28.E01)



Active 3D glasses
- DGDS (5J,J9H25.001)



Spare lamp kit
- (Lamp1: 5J,J8C05.001)
- (Lamp2: 5J,J8C05.002)



Key Features

- Horizontal & Vertical lens shift
- Horizontal & Vertical keystone
- Corner fit
- 1.5X flexible zoom
- Dust filter free design
- HDBaseT
- Dual HDMI inputs
- VGA signal power on
- Direct power on/off
- Compatible with Crestron / AMX / PJLink / Extron
- Sleep timer
- Supports all 3D mandatory formats
- Standby power <0.5W (network off)
- SmartEco energy saving
- Eco Blank mode
- Panel key lock
- Kensington lock
- Variable audio out
- Top access lamp door
- RoHS compliant
- 2X digital zoom
- Quick auto source search
- Closed captioning

BenQ Europe B.V.

Meerenakkerweg 1-17
5652 AR Eindhoven
The Netherlands
Tel: +31 88 888 9200
Fax: +31 88 888 9299



Because it matters