

Projection Distance Chart

Screen diagonal (inch)	Display size (16:9)		Projection distance	
	W (mm)	H (mm)	Wide (m)	Tele (m)
60	1,328	747	1.78	3.66
70	1,549	872	2.09	4.28
80	1,771	996	2.40	4.89
90	1,992	1,121	2.70	5.51
100	2,214	1,245	3.01	6.13
110	2,435	1,370	3.31	6.75
120	2,656	1,494	3.62	7.36
130	2,878	1,619	3.92	7.98
140	3,099	1,743	4.23	8.60
150	3,320	1,868	4.53	9.22
160	3,542	1,992	4.84	9.84
170	3,763	2,117	5.14	10.45
180	3,984	2,241	5.45	11.07
190	4,206	2,366	5.75	11.68
200	4,427	2,490	6.06	12.30

*Projection distances are design specifications, so there is ±5% variation.

Optional Equipment



PK-L2310U
User-replaceable Lamp
Not suitable for household room illumination



PK-AG3
RF Method
3D Glasses



PK-EM2
RF Method
3D Synchro Emitter

Connectors



DLA-X900R/X700R/X500R DLA-X35

External Dimensions (unit: mm)

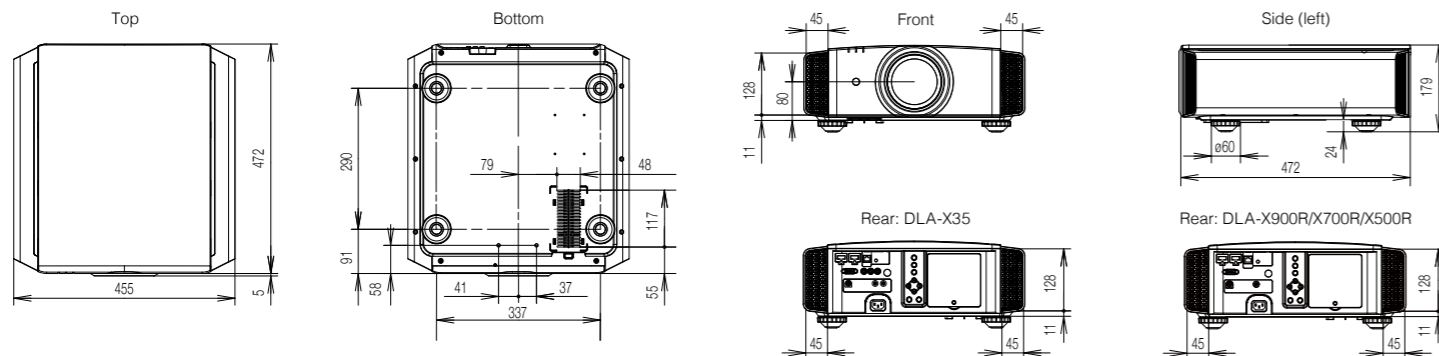

•D-ILA is a registered trademark of JVC KENWOOD Corporation. •e-shift is a registered trademark of JVC KENWOOD Corporation. • The projector is equipped with an ultra-high pressure mercury lamp, which may break, emitting a loud noise, when it is subjected to shock or after it has been used for some length of time. • Please note that, depending on how the projector is used, there can be considerable difference between individual lamps regarding how many hours they will operate before requiring replacement. • An additional payment is required for installation of a new lamp, if necessary. • The projector lamp requires periodic replacement and is not covered by warranty. • Please be aware that, because the D-ILA device is manufactured using highly advanced technologies, 0.01% or fewer of the pixels may be non-performing (always on or off).

Design and specifications are subject to change without notice. All pictures on this brochure are simulated. Adobe is a trademark or registered trademark of Adobe Systems Incorporated in the U.S. and/or other countries. ISF is a registered trademark of Imaging Science Foundation, Inc. THX and THX logo are trademarks of THX Ltd., which may be registered in some jurisdictions. HDMI, the HDMI logo and High-Definition Multimedia Interface are registered trademarks of HDMI Licensing LLC. All other brand or product names may be trademarks and/or registered trademarks of their respective owners. Any rights not expressly granted herein are reserved.

Copyright © 2013, JVC KENWOOD Corporation. All Rights Reserved.



DISTRIBUTED BY

www.jvc.eu
www.jvc-asia.com

Printed in Japan
CCKR-3733-13
"JVC" is the trademark or registered trademark of JVC KENWOOD Corporation.



D-ILA PROJECTORS

DLA-X900R
DLA-X700R
DLA-X500R
DLA-X35



4K
e-shift3



The Next Stage in 4K

4K
e-shift3



DLA-X900R

D-ILA Projector with 3D Viewing



- Industry's highest dynamic contrast ratio: 1,500,000:1*
- Industry's highest native contrast ratio: 150,000:1*
- Brightness: 1,300 lumens

*As of November 1, 2013 JVC data.



DLA-X700R

D-ILA Projector with 3D Viewing



- Dynamic contrast ratio: 1,200,000:1
- Native contrast ratio: 120,000:1
- Brightness: 1,300 lumens



DLA-X500R

D-ILA Projector with 3D Viewing



- Dynamic contrast ratio: 600,000:1
- Native contrast ratio: 60,000:1
- Brightness: 1,300 lumens

Original technologies to realise high-precision and high-definition 4K images

Newly Developed Proprietary D-ILA Device

The exceptional picture quality of JVC projectors is achieved by the precision technology behind the company's original D-ILA devices. The latest device, which has an even narrower gap between pixels and is planarised, achieves brighter images rich with contrast. The device is optimally designed to complement ultra-high 4K resolution for precision image expression with virtually no screen-door effect.

D-ILA

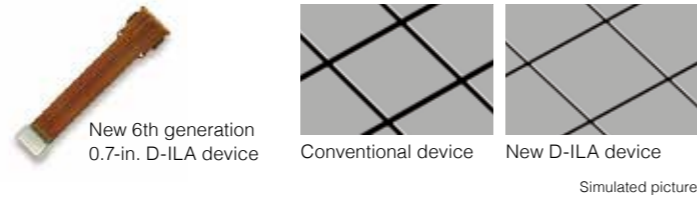

New e-Shift 3 Technology

JVC's e-Shift technology shifts sub-frames by 0.5 pixel both vertically and horizontally to achieve 4 times the pixel density of the original content. Optimised for the new D-ILA device, the latest e-Shift 3 Technology boosts definition to a higher level.

4K e-shift3

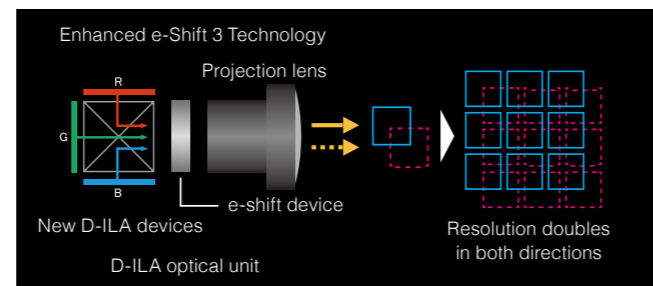

Multiple Pixel Control

High-performance image processing technology is necessary for the precise reproduction of full HD sources on a 4K projector. JVC improved its Multiple Pixel Control technology featured on new models. In addition to wide-range picture detection and high-performance 8-band filtering,

Auto Mode has been added that performs frame adaptive filtering and picture generation to achieve a high-definition image optimal for a variety of scenes. Multiple Pixel Control lets the user experience immersive 4K images without complicated picture adjustments.

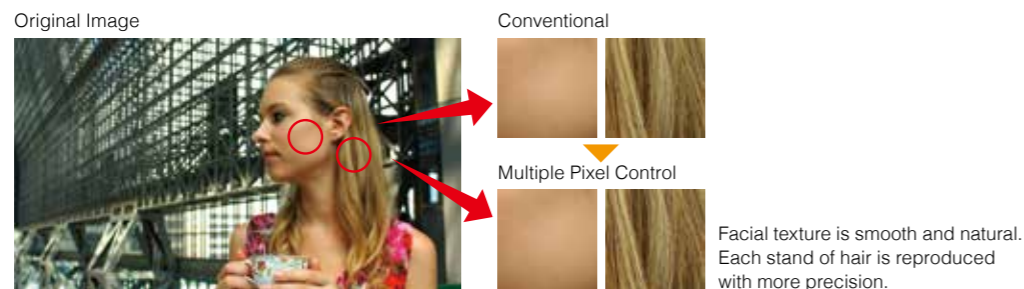
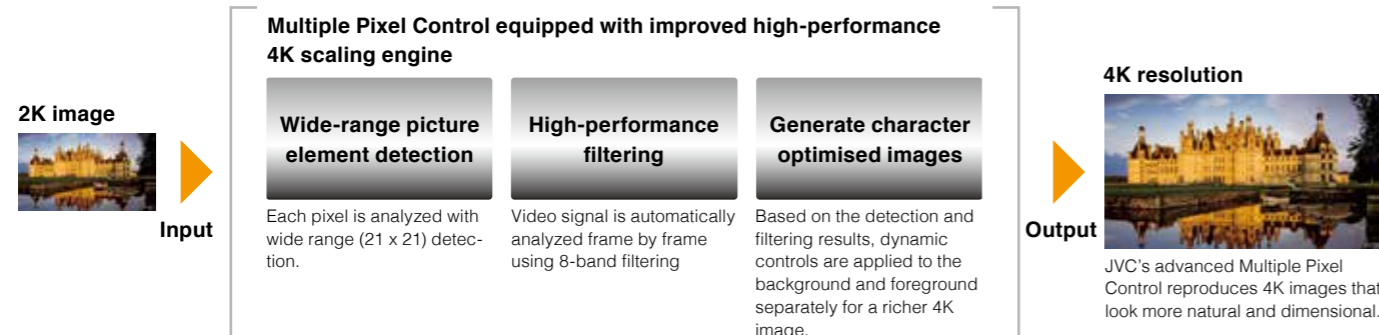

Contrast and colour imaging technologies to recreate images with realistic sensation.

The Industry's Highest Dynamic Contrast Ratio of 1,500,000:1* Achieved with the Industry's Highest 150,000:1 Native Contrast Ratio*

The combination of JVC's original D-ILA device and an optical engine equipped with new wire grid to improve polarisation performance results in the industry's highest contrast ratio of 150,000:1*. What's more, the industry's highest 1,500,000:1* dynamic contrast range is realised with the newly developed Intelligent Lens Aperture that optimally adjusts black level using an original algorithm to analyze the input video source, and Clear Black that boosts the contrast between light and dark. Enjoy high-definition video full of reality that can only be achieved with such a high native contrast ratio.



* As of Nov. 1, 2013, JVC data

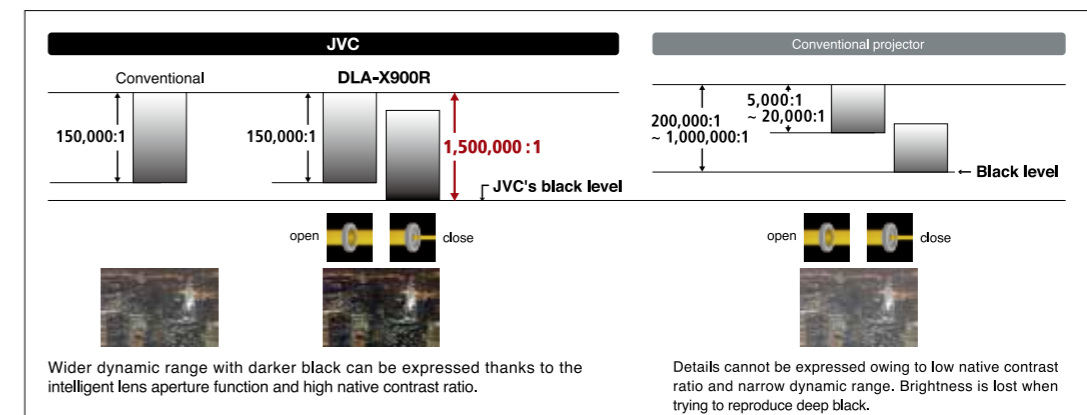

Brightness of 1,300 lumens to Reproduce High Chromatic Purity

1,300 lumens brightness is achieved by virtue of a new optical engine equipped with new device that uses light more efficiently. A bright picture with high chromatic purity is realised thanks to optic design that excels in real-life usage situations.

JVC's Unique Real Colour Imaging Technology (DLA-X900R/X700R)

JVC original-development Real Colour Imaging Technology realises wider colour reproducibility and dramatically improves colour rendition with settings for Xenon lamp colour temperature and new dedicated colour profiles. Combined use of picture quality modes and dedicated colour profiles results in 23 different ways to enjoy high quality images.

• Supports x.v.Colour for Wide Colour Space Reproduction

Featuring a colour space wider than that of Adobe RGB or DCI, the D-ILA projectors vividly reproduce a fuller spectrum of colours such as the green of trees, the blue of oceans, etc., which is difficult to recreate accurately. Even wider "x.v.Colour" colour space is supported, enabling viewers to enjoy 4K video with rich colours incorporated in the original 4K source.

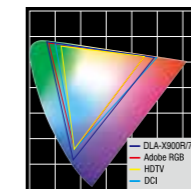

• Featuring a Photo Mode that reproduces the texture of photographs

Picture Mode now features a new Photo Mode. Subtle textures and colours contained in still photos are precisely reproduced to enable dynamic pictures to be enjoyed on the big screen.

• Xenon-lamp Colour Temperature Setting

Supports a colour temperature setting Xenon Mode, which is equivalent to that of a Xenon lamp, a popular light source used in cinemas. This setting allows for the authentic reproduction of colours similar to those of film in cinemas, while using highly efficient and economical ultra-high pressure mercury lamps.

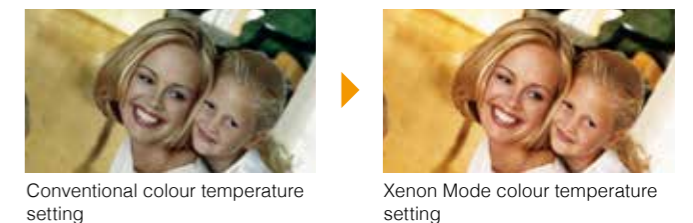

Picture adjustment functions and convenient features

Clear Motion Drive 3

Dramatic improvement has been applied to JVC's original Clear Motion Drive, including the adoption of a motion detection algorithm and high-speed LSI to drastically reduce ghosting or afterimage in high-speed scenes. This function works for 4K and 3D images to recreate clear and smooth movement in the picture.

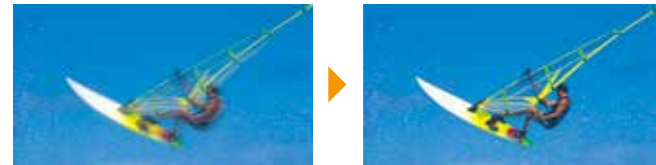

Clear Motion Drive: Off

Clear Motion Drive: On

Colour Management System with 7-Axis Matrix

A 7-axis matrix of red, green, blue, cyan, magenta, yellow, and orange ensures the precise adjustment of hue, saturation, and intensity. Selection of the colour spectrum such as skin tones can be easily performed.

Screen Adjustment Modes

The projector selects the best mode to match the screen being used for images with natural colour balance.



Screen adjustment mode Off

Screen adjustment mode On

* Please refer to JVC website for a comparison table of primary screens and adjustment modes.

Pixel Adjust Function

The Pixel Adjust function allows users to precisely correct colour deviation in 1/16-pixel increments. It is also capable of segmenting the entire screen into 121 points and adjusting them individually to realise clearer video without colour deviation. Two settings can be stored in the memory.

Lens Memory Function

This function stores ten separate lens adjustments for zoom, shift and focus that can be easily recalled when needed. Memory settings can be switched between each setup via the remote controller.

Lens memory examples (when using CinemaScope screen)



Memory 1: Standard 16:9

Memory 2: CinemaScope size



Memory 3: CinemaScope size with subtitles outside of the screen

High Quality 3D Images of D-ILA

In addition to JVC's original Frame Addressing method to reproduce 3D images with vivid colours, the optical engine featuring a set of new D-ILA devices is capable of achieving more brightness. Furthermore, 3D image adjustment functions such as Crosstalk Cancelling are featured to offer the kind of realistic and exciting 3D images that only D-ILA can provide.

RF (Radio Frequency) Method

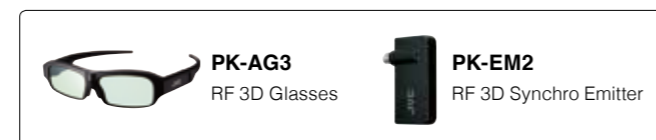

Notes about viewing 3D video content

- The optional 3D Synchro Emitter and 3D glasses are required to view 3D images from the D-ILA projectors. 3D video software (3D media or output of 3D broadcasts) and a 3D-compatible video player are also required.
- Perception of 3D images will vary with individual viewers.
- Stop viewing 3D images immediately if any discomfort such as headaches, dizziness, eye fatigue, etc. occurs.
- Viewing of 3D images by children under the age of five is not recommended.
- Read the Safety Precautions in the User Manual carefully before viewing any 3D source.

Smoothly Control the Projector via a Smart Device

JVC D-ILA projectors can be controlled from smart devices such as smartphones and tablets. The smart device remote control app features an intuitive graphical UI and exclusive controls not found on the projector's supplied remote control for easy operation. Additionally, there are built-in help functions for smoother operation.

Auto-calibration Function*

Using an optical sensor, precise calibration can be performed in just a few easy steps, to match the installation situation of the projector such as its location, lens shift/zoom position, etc.

* Exclusive JVC software installed on a PC connected to the projector via a LAN connection and optical sensor are required to set viewing configurations and auto calibration. Please visit the JVC website for the details.

Industry Certified Projectors — THX 3D Display Certification (DLA-X900R/X700R)

■ THX 3D Display Certification*



* Ideal screen-size performance is 90 inches diagonal (16:9).

■ Equipped with ISF (Imaging Science Foundation) Certified Calibration Controls (C3) mode



3D entry class projector enables high quality viewing even in bright living rooms by virtue of 1,300 lumens brightness and 50,000:1 native contrast.



DLA-X35

D-ILA Projector with 3D Viewing



- Bright picture realised with brightness of 1,300 lumens and native contrast ratio of 50,000:1
- Bright 3D viewing with reduced crosstalk only possible with D-ILA
- 6 Picture Modes and 3 Colour Spaces
- Environmental Setting
- 5-mode Lens Memory
- 3 Screen Adjustment Modes
- Pixel Adjust by 1 pixel increment



Feature Comparison

Model	DLA-X900R	DLA-X700R	DLA-X500R	DLA-X35
4K capability*1	●	●	●	—
4K signal input*2	●	●	●	—
3D capability	●	●	●	●
2D-3D converter	●	●	●	●
Multiple Pixel Control	●	●	●	—
Environmental setting	●	●	●	●
Auto calibration*3	●	●	●	—
Picture Data In/Out*4	●	●	●	—
Picture Tone	●	●	●	—
Pixel Adjust	● (by 1/16-pixel increment, 2 memories)	● (by 1/16-pixel increment, 2 memories)	● (by 1/16-pixel increment, 2 memories)	● (by 1-pixel increment, 1 memory)
Lens Memory	● (10 memories)	● (10 memories)	● (5 memories)	● (5 memories)
Clear Motion Drive	Ver.3	Ver.3	Ver.3	Ver.2
THX 3D Display Certification	●	●	—	—
ISF C3 mode	●	●	—	—
MPC Analyser	●	●	●	—
Real Colour Imaging Technology	●	●	—	—
Colour Management	7-axis	7-axis	7-axis	—
Colour Temperature (Xenon-lamp mode)	●	●	—	—
Screen Adjustment Mode	106 Modes (up to 255 modes)	106 Modes (up to 255 modes)	106 Modes (up to 255 modes)	3 modes
Clear Black	●	●	●	—
Darkness and Lightness Correction	●	●	●	—
Digital Keystone*1	Vertical direction	Vertical direction	Vertical direction	Both directions
Anamorphic Mode	●	●	●	●
Intelligent Lens Aperture	●	●	●	—
Lens Aperture	—	—	—	● (16 steps)
Automatic Lens Cover	●	●	—	—

*1 This function cannot be used while projecting in 3D mode. *2 50p/60p compatible with 4:2:0 colour base. *3 Requires a commercially available optical sensor and dedicated software as well as PC and LAN cables. *4 Requires dedicated software as well as PC and LAN cables.