



- /// WXGA 5200 Lumens
- /// Lens shift
- /// Interchangeable Lenses
- /// Full 3D Support

# W505

*Spectacular image quality, outstanding  
brightness and ultimate reliability*



PRO | SCENE

# Features



## W505 features

-  5200 Lumens, WXGA Resolution
-  Installation flexibility – Lens shift, interchangeable lenses, off-axis short throw option
-  Ultimate Control - Full support for Crestron, Extron, AMX, PJ-Link and Telnet LAN commands
-  Powerful Image Blending tools - 3-axis colour matching system and 10x lamp-power steps
-  Advanced features – Wired Remote, Full 3D Support and DICOM simulation



# Image Quality



Superb image quality is at the heart of every ProScene product design. At every step, commencing with the incredibly reliable, high resolution WXGA DLP® chip where the image is initially created, via the UHP lamp pulsing technology that fine tunes the colour to exacting standards, through to the precision optics to focus the image on a screen, accuracy and integrity of the image are paramount.

ProScene chose DLP® technology for its image quality and unmatched reliability. The reflective nature of DLP® micro-mirror technology provides highly efficient bright images with great contrast whilst maintaining precise colour accuracy and natural, real-world colour reproduction. For demanding professional applications, the proven reliability of DLP® technology makes it the obvious choice.

## DLP® Technology

DLP® technology from Texas Instruments® is widely recognised and acclaimed for its unmatched reliability and long lasting image performance. When combined with high brightness and native contrast ratios, it becomes the obvious choice for demanding applications. Independent testing has proven DLP® to be the most reliable of projector technologies. Whilst other technologies may show image quality decline after only a few thousand hours, DLP® technology can remain unchanged over hundreds of thousands of hours.



## True WXGA Resolution

Documents and presentations will appear as sharp and detailed as they do on your widescreen laptop in WXGA (1280 x 800) resolution, which also gives you 30% more pixels than an equivalent XGA projector.



XGA



WXGA

## UHP lamps

The 370W UHP lamp provides the highest possible luminance, the essential prerequisite of all highly efficient projectors.

These lamps have outstanding brightness, stay brighter for longer, and provide an optimal colour spectrum. In addition, the lamp drivers are specifically tuned for the lamps, ensuring not only optimum operating conditions for every situation, but also provide sophisticated lamp pulsing modes and the assurance that colour can be fine-tuned according to the application.

## Clear, Focused Images

DarkChip3™ technology from Texas Instruments produces a stunning 2000:1 contrast ratio for pin sharp graphics and crystal clear text. Crisper whites, ultra-rich blacks makes images come alive and text easier to read.



2000:1 Contrast Ratio

## Amazing Colours

The W505 incorporates BrilliantColor™ technology to produce stunningly bright images with perfectly balanced life-like colours.



# Flexibility



## Installation Flexibility

To help meet the seemingly limitless challenges of ProAV installations, the W505 provides multiple lens options with zoom and focus adjustment to ensure you can get the image size you require, while a wide lens shift range helps you get the image exactly where you want it.



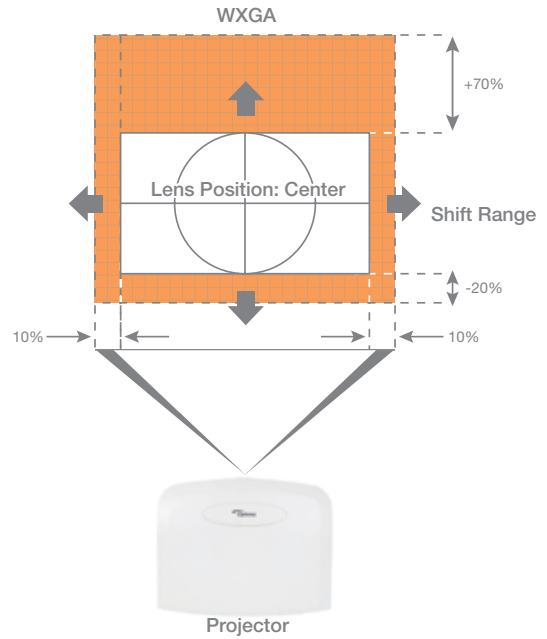

## Full Lens Shift



All 3 optional lenses, including the 0.77:1 short throw lens can use the full lens shift range.

## Lens Options

			
<b>Lens Type</b>	<b>Short</b>	<b>Standard</b>	<b>Long</b>
Throw Ratio	0.77:1	1.54 - 1.93:1	1.93 - 2.89:1

## Throw Distance Chart

W505 Throw Distance					
Diagonal Image Size (16:10)	Short	Standard		Long	
	Fixed (m)	Min (m)	Max (m)	Min (m)	Max (m)
50"	0.82	1.66	2.08	2.08	3.11
60"	1.00	1.99	2.49	2.49	3.73
70"	1.16	2.32	2.91	2.91	4.36
80"	1.33	2.66	3.33	3.33	4.98
100"	1.67	3.32	4.16	4.16	6.23
150"	2.48	4.98	6.24	6.24	9.34
200"	3.32	6.64	8.32	8.32	12.45
250"	-	8.29	10.39	10.39	15.56
300"	-	9.95	12.47	12.47	18.68

For guide purposes only

# Features

## DICOM simulation mode

Designed specifically for larger meeting rooms and lecture theatres, the W505 includes a special DICOMsim mode that has been specifically tuned for viewing greyscale images, perfect for viewing X-rays and scans during medical training.\*



\*The W505 is not suitable for use in medical diagnosis.

## 3D Technology

Using the inherent speed of DLP® technology, Optoma Full 3D projectors can output video and images at an astonishing rate of 120Hz, allowing you to show full screen, full colour, stereoscopic 3D. The 3D effect is generated by splitting this signal into two standard video streams, one for each eye. Using DLP® Link™ technology, the 3D glasses synchronise with the image on screen to filter each stream to the correct eye. Your brain then combines the two streams to make them jump into life.

The W505 supports multiple 3D formats from various devices such as PC, Blu-ray 3D™, Sony® PS3, Microsoft® Xbox 360 or 3D TV broadcast system.

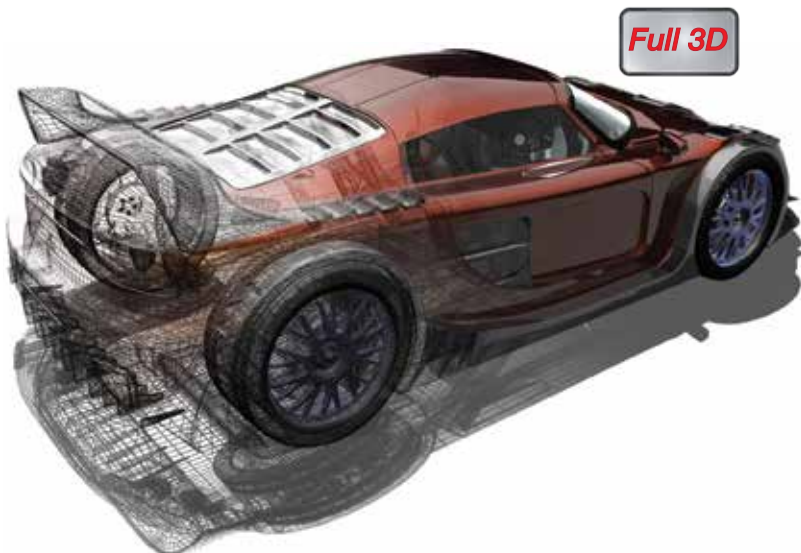

## Edge Blending Tools

No two projectors are completely identical. When performing complex, or even simple edge-blend projects using multiple projectors, it can be difficult to achieve good results if the images do not match. The W505 incorporates the following features to ensure high quality and consistent results.

## Colour matching

The W505 has a full 3-axis colour matching system, which combined with accurate measurements can create seamless blends every time.

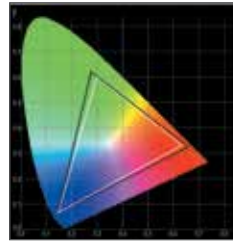

## Brightness matching

The brightness of a projector will vary throughout its life. To correctly match multiple units, the W505 has 10x lamp power steps between 80~100% full brightness.



Without



With

## Wired Remote

The wired remote connection allows all aspects of the projector to be individually controlled without requiring a line-of-sight to the projector; invaluable when using multiple units during live events.



## Control



### System Integration Control

Multiple W505 can be monitored over LAN and can also provide the user with an email message alert in case an error occurs or a lamp fails or needs to be replaced using Crestron Roomview. The web browser interface and full support for Telnet, Extron's IP Link, AMX dynamic device discovery and PJ-Link protocols, allow almost all aspects of the W505 to be controlled across a network, keeping you in control, wherever you are.

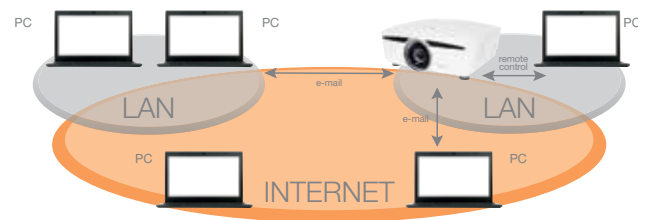
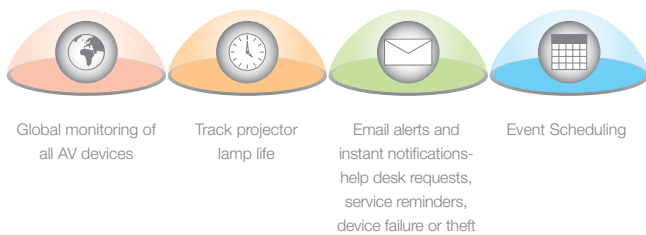

### Ultimate control

Cut up to 30% from your energy bills using 24-hour automated power scheduling to ensure that projectors power off when not in use.



Download Crestron RoomView® Express for free at [www.crestron.com/getroomview](http://www.crestron.com/getroomview)

### Selected View by Rooms, Attributes or Contacts

RoomView Express gives you the ability to simultaneously view more than 250 connected devices from a single screen. Customise RoomView to view by room name, locations and group.

### Display Power

Check on/off status of any projector.

### Display Usage

View a bar graph to monitor the percentage of available projector lamp life and set an alert to notify the services department when a replacement lamp should be ordered, before the lamp fails.

### Schedule Events

RoomView Express makes scheduling of recurring or one-time events easy. Setting RoomView to automatically power down at midnight throughout the week can save valuable lamp life and ensure security inside the facility.

### Event Log

Automatically generates log files, reports and charts to analyze ROI and budget allocation. Track device usage, call statistics and user history.

## Eco Friendly

Cut up to 30% from your energy bills using 24-hour automated power scheduling to ensure that projectors power off when not in use.



We know that improving our products is the best way to reduce our impact on the environment. That's why at Optoma, we design our products to have a long usable life, use fewer materials, ship with the minimum packaging and be free of all possible toxic substances. Naturally, energy efficiency and being recyclable are built in at the design stage. With each new product, we strive towards minimising our environmental impact. For full details of Optoma Project Green please visit our website.



### Direct Power On

The projector will start up instantly when power is supplied to the Unit. This eliminates the need to manually turn on the projector via the remote control or the keypad, ideal for use in rooms with a "master" power switch.



### Signal Power On

The projector will power on when it receives a signal through one of the PC/video inputs. This ensures that the projector is only switched on when it is needed.



### Auto Power Off

If after a pre-determined time the projector does not receive a signal, it will turn itself off automatically, conserving power and extending the life of the lamp.



### Eco Standby Mode

Reduces energy consumption to less than 0.5W when the projector is not in use.



### Eco AV Mute & Eco Sleep

Direct your audience's attention away from the screen by blanking the image when no longer needed. When Eco AV-mute is enabled, or if no source is found after 60 seconds, the projector will automatically put the lamp into Eco mode, both saving power and further prolonging the life of your lamp.



# Dimensions

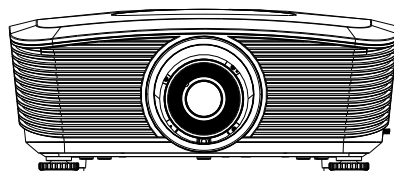
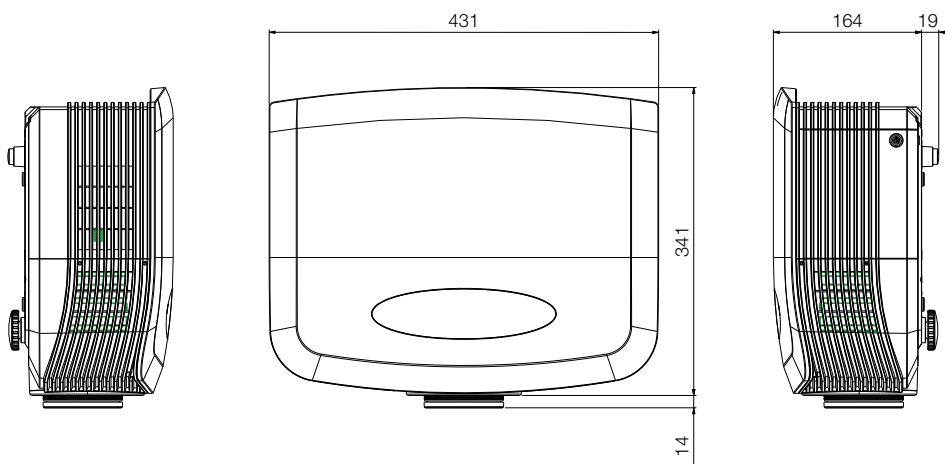
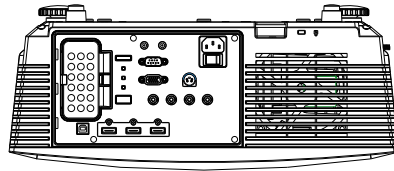



# Labelling

## Easy to use remote control

1. Power Off
2. Mouse
3. Function 2 (assignable)
4. AV Mute / right mouse button
5. Laser
6. Re-Sync
7. V Keystone +/-
8. Menu
9. Remote code All
10. Remote code 01~99
11. HDMI 2
12. HDMI 1
13. DVI
14. 3D Mode
15. DisplayPort
16. Component Video
17. BNC
18. Composite video
19. VGA 2
20. S-Video
21. VGA 1
22. Zoom
23. Format (aspect ratio)
24. Volume Up/Down
25. Source
26. Information Panel
27. Four Directional Select Keys
28. Display mode / left mouse button
29. Function 1 (assignable)
30. Test Pattern
31. Power On

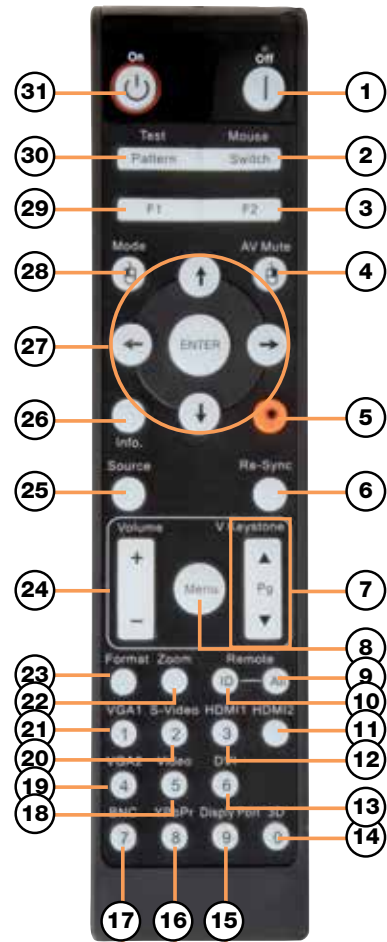

## Input/Output Connections

32. Power On/Off
33. VGA 1
34. HDMI
35. VGA 2
36. DVI
37. DisplayPort
38. RJ45 LAN
39. USB Power
40. 3D Sync
41. VGA Out
42. 5BNC
43. RS-232C
44. Wired Remote
45. +12V Trigger (3.5mm)
46. Composite Video
47. S-Video
48. Component Video
49. Master Switch

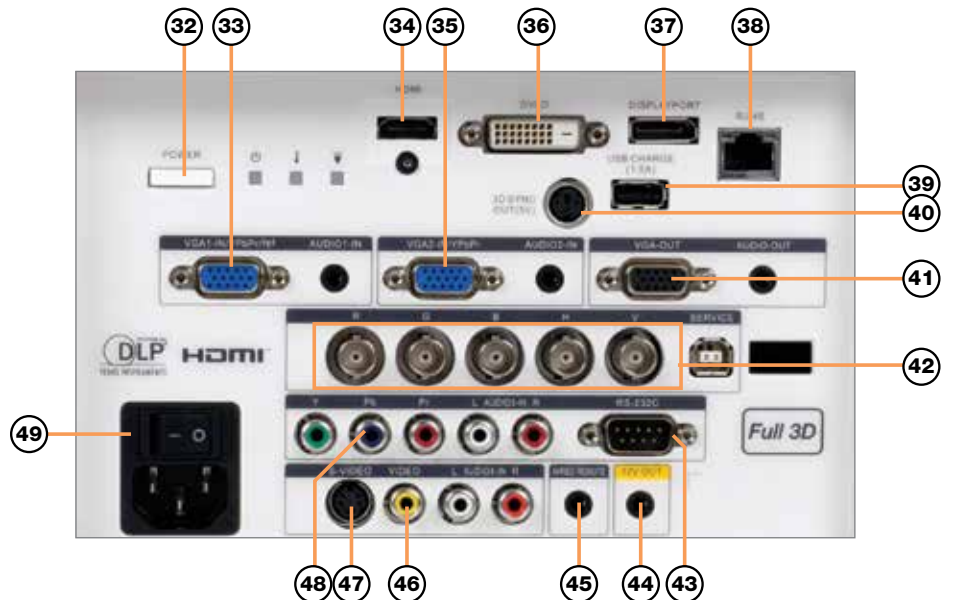

# Technical Specifications

Projector		
		DLPTM Technology by Texas Instruments
	Technology	0.65" WXGA, Type A chip
	Resolution Native	WXGA (1280 x 800)
	Brightness <sup>1</sup>	5200 ANSI Lumens
	Aspect Ratio	16:10 native, 4:3 & 16:9 compatible
	Refresh Rate	15kHz to 91kHz / 24Hz to 85Hz (120/144Hz for 3D playback)
	Contrast	2000:1
	2D Video Compatibility	PAL (625/576i/p), SECAM, NTSC (525/480i/p), HDTV (720p, 1080i, 1080p)
	3D Video Compatibility	Mandatory HDMI 1.4 3D formats, 120Hz frame sequential (up to 720p)
Optics		
	Lamp Type	370W UHP
	Lamp Life <sup>2</sup>	1500 hr Bright Mode / 3500 hr Eco Mode
	Lens Shift	Manual +70%, -20%V, +/-10% H
	Lenses (no lens supplied as standard)	
	Short	0.77:1
	Standard	1.54 - 1.93:1
	Long	1.93 - 2.89:1
	Keystone Correction	Vertical ±40°
	Uniformity	85% (centre)
Connectivity		
	Inputs	HDMI (with locking Screw) DVI-D (HDCP supported) DisplayPort BNC (RGBHV) PC RGB 2 x 15 pin D-Sub VGA Component 3RCA S-Video/Composite 4 pin Mini DIN / RCA
	Output	PC (monitor loop-through) VGA Out +12V trigger (3.5mm jack) 3D-Sync Out (3-Pin VESA)
	Control and Communication	RS232 9 pin D-SUB RJ45 (Crestron/Extron/PJ-Link/Telnet) Wired Remote (3.5mm jack)
General		
	Noise Level	37dB
	Weight	8.6Kg (without lens)
	Dimensions (W x D x H)	431 x 341 x 183mm
	Power Requirements	100 – 240V AC @ 50 – 60Hz
	Power Consumption	460W (max) bright mode, <0.5w standby mode
	Operating Conditions	5 – 40°C, max. humidity 85%, max. altitude 3000m
	Portrait mode	Not supported
	360° Operation	Not supported
	Operating Temperature	0 ~ 750m, 5 ~ 45°C 750m ~ 1500m, 5 ~ 35°C 1500 ~ 3000m, 5 ~ 30°C
	Environmental	RoHS and WEEE
	Conformances	CE, TUV-GS, CB
	Security	4-digit PIN code Kensington Lock port Security Bar
	Warranties	3 Years
Supplied Accessories		
	Cables	VGA cable AC power cord
	Other	Infra-red remote control (selectable IR code sets for controlling multiple units) Batteries x 2 Quick start card Warranty card WEEE card

# Accessories



## Universal Ceiling Mounts

### Flush Mount

**White P/N: OCM818W-RU**

**Black P/N: OCM818B-RU**

The Universal Flush Mount is easy to set up with its unique low-profile design to give you everything you need for quick adjustment and the flexibility to install almost any projector hassle-free.



### Pole Mount

**White P/N: OCM815W**

**Black P/N: OCM815B**

The Universal Pole Mount is height adjustable from 290mm~810mm. Suitable for virtually any projector under 15Kg. The mount comes pre-assembled with a quick projector disconnect/reconnect for rapid installation, while the 360° rotation and more than +/- 20° tilt/roll provide the flexibility to install almost anywhere. (including vaulted ceilings) Lastly, an integrated cable routing channel ensures a clean, professional finish.



# Accessories Continued



## Optimised edge blending (Available direct from Optoma)

Optoma have worked in partnership with Calibre to produce special versions of Calibre's ultra low-latency edge blending and warping products optimised for use with our ProScene projectors. This unique collaboration significantly reduces the complexity and configuration time required to edge blend multiple ProScene projectors and is covered by the industry leading ProScene technical support services should you require assistance with your edge blending project.



### HQView320 HQV™ Scaler with Warp and Edge Blend

Best in class professional image processing in a compact affordable module.



### HQView325 HQV™ Scaler with Warp Mapping Edge Blend & HDMI/DVI In/Out

HQView325 features 4-sided soft edge blend with multi-region black level correction for seamless blending of multiple projectors.



### HQView520 Universal HQV™ Scaler-Switcher-Scan Converter with Warp, Edge Blend & 3G-SDI In/Out

Use as a routing switcher and universal interface for 3G-SDI, HD-SDI, DVI or HDMI



### HQView530 LCD Screen HQV™ Scaler-Switcher with 3G-SDI

HQView530 is a highly flexible video screen image scaler which provides stunning image quality for professional, broadcast, sports, digital signage & corporate AV.



# Offices



## Worldwide technical and commercial support

### Optoma Europe

#### Optoma Europe Ltd.

42 Caxton Way  
The Watford Business Park  
Watford  
Hertfordshire  
WD18 8QZ  
UK  
Tel: +44 (0) 1923 691 800  
Fax: +44 (0) 1923 691 888

#### Optoma Deutschland GmbH

WIESENSTRASSE 21  
D40549 Düsseldorf  
Germany  
Tel: +49 (0) 211 506 6670  
Fax: +49 (0) 211 506 66799

#### Optoma France

Batiment E  
81-83 avenue Edouard Vaillant  
92100 Boulogne Billancourt  
France  
Tel. : +33 (0) 1 41 46 12 20  
Fax: +33 (0) 1 41 46 94 35

#### Optoma Spain

C/ José Hierro,36 Of. 1C  
28529 Rivas VaciaMadrid  
Madrid  
Spain  
Tel: +34 91 499 06 06  
Fax: + 34 91 670 08 32

#### Optoma Benelux

Optoma Benelux BV  
Randstad 22-123  
1316 BW Almere  
The Netherlands  
T: +31 (0) 36 820 0252  
F: + 31 (0)36 548 9052

#### Local Representatives

Turkey

UAE

Poland

Russia

Italy

### Optoma Scandinavia

#### Optoma Scandinavia

Lerpeveien 25  
Postboks 9515 Åskollen  
3038 Drammen  
Norway  
Tel: +47 32 98 89 90  
Fax: +47 32 98 89 99

### Optoma USA

#### Optoma USA Headquarters

3178 Laurelview Ct.  
Fremont, CA 94538  
Tel: (510) 897-8600  
Fax: (510) 897-8601

#### Atlanta Sales Office

7000 Central Park NE, Suite 570,  
Atlanta, GA 30328  
Tel: (678) 281-2228  
Fax: (770) 399-3035

#### Canadian Sales Office

2420 Meadowpine Blvd, Suite 105,  
Mississauga, ON L5N 6S2, CANADA  
Tel: (905) 285-0685

### Optoma Asia

#### Taiwan

Optoma Corporation  
Taipei Office  
5F., No. 108, Minchiuan Rd. , Shindian City,  
Taipei Taiwan 231, R.O.C.  
Tel: +886-2-2218-2360  
Fax: +886-2-2218-2313  
<http://www.optoma.com.tw>

#### Taichung Office

7F-5, No.3, Lane 2, 1st Rd, Taichung Industrial  
Park, Xitun Dist., Taichung City, 40767, Taiwan,  
R.O.C.  
Tel: +886-4-3505-0336  
Fax: +886-4-3505-0338

#### Kaohsiung Office

Rm. D, 7F, No.108, Zhonghua 3rd Rd., Qianjin  
Dist., Kaohsiung City 80145, Taiwan, R.O.C.  
Tel: +886-7-952-5689  
Fax: +886-7-241-2197

### China

Shanghai Office  
5F, No. 1205 Kaixuan Road, Changning  
District , Shanghai  
Tel: +86-21-6294-7376  
Fax: +86-21-6294-7375  
<http://www.optoma.com.cn>

#### Beijing Office

20D apartment 3, Build No.3, Yindu Tower, No  
48 ZhiChun road, HaiDian district, Beijing  
Tel: +86-10-5873-1919  
Fax: +86-10-5873-1919 \*8018

#### ShenYang Office

Room1201, building C3, Wulihe Tower, No 4-1  
WenTi road, HePing district, ShenYang  
Tel: +86-024-3188-7018  
Fax: +86-024-3188-7018-808

#### Xi'an Office

Room 1310, building B, ShiMao tower,  
GuanDongZheng street, Xi'an  
Tel: +86-029-8228-2428  
Fax: +86-029-8228-2428

#### GungZhou Office

Room 602, NanTie Tower, No.57  
No.1ZhongShan road, YueXiu district,  
GungZhou  
Tel: +86-20-6128-0990 / 6128-1025  
Fax: +86-20-6128-1027

#### ChongQing Office

Room 9-2, building 19 HuaYuMingDu,  
ShiQiaoPu, ChongQing  
Tel: +86-23-6879-7626  
Fax: +86-23-6879-7725

#### ChengDu Office

Room A3 floor 20, building A Time digital  
square, No.1 South RenMin road, ChengDu  
Tel: +86-28-8523-1553 / 8631-7092

#### Hong Kong Office

Unit A, 27/F., Dragon Centre, 79 Wing Hong  
Street, Cheung Sha Wan, Kowloon, Hong Kong  
Tel: +852-2396-8968  
Fax: +852-2370-1222  
<http://www.optoma.com.hk>



**Optoma Europe Ltd.**

42 Caxton Way, Watford Business Park, Watford, Hertfordshire, UK. WD18 8QZ

**[www.optoma.eu](http://www.optoma.eu)**



<sup>1</sup>Brightness and lamp lifetime will vary depending on selected projector mode, environmental conditions and usage. As is common with all lamp based projectors, brightness will decrease over the lamp lifetime. <sup>2</sup>Typical lamp life achieved through testing. Will vary according to operational use and environmental conditions. Optoma guarantees that in normal use, Optoma DLP<sup>®</sup> colour quality will be indistinguishable from when new. Exclusions: (a) Guarantee is voided if the projector is subject to damage through misuse. (b) Guarantee may be void in industrial or commercial entertainment environments where dust or smoke is excessive (c) Guarantee will not apply if lamp brightness is below 50% due to wear or if the projector is not working due to other faults. (d) Over time worn lamps within all projector types will show a slight colour variance. Copyright © 2013, Optoma Europe Ltd. All other product names and company names used herein are for identification purposes only and may be trademarks or registered trademarks of their respective owners. Crestron<sup>®</sup>, the Crestron and RoomView<sup>®</sup> logo are registered trademarks of Crestron Electronics, Inc. Errors and omissions excepted, all specifications are subject to change without notice. DLP<sup>®</sup>, BrilliantColor<sup>™</sup> and the DLP logo are registered trademarks of Texas Instruments. All images of products are for representation purposes only. Whilst every care is taken to provide accurate images of our products, actual products may differ slightly. Some product images may have been digitally altered by us to add an Optoma logo to the front panel. Optoma reserves the right to amend or alter actual product or product images without notice. Some images may be simulated.