



- WUXGA 7500 Lumens
- Lens shift
- Extensive lens options
- Dual lamp

# EH7700

*Spectacular image quality, outstanding  
brightness and ultimate reliability*



PRO | SCENE

## PRO|SCENE

For more than ten years Optoma has been one of the world's foremost projector designers and manufacturers - amongst the very few companies that focus exclusively on projectors.

Today the Optoma ProScene range represents the evolution of projection expertise, honed and refined by manufacturing and supporting millions of projectors the world over. This knowledge and skill has been distilled into the ProScene products and support services which are designed specifically for demanding professional applications.

- ✓ Higher education
- ✓ Lecture theatres
- ✓ Houses of worship
- ✓ Museums
- ✓ Auditoriums
- ✓ Boardrooms
- ✓ Broadcast studios
- ✓ Large classrooms
- ✓ Exhibitions
- ✓ Conference rooms
- ✓ Digital signage
- ✓ Stage shows
- ✓ Live events
- ✓ Projection Mapping
- ✓ Meeting rooms
- ✓ Post production
- ✓ Theatre
- ✓ Trade shows

### ProScene Certified Partners

Optoma understands that for ProScene customers, their high specification projector must be of exceptional quality and that the level of support and expertise provided by AV installers and integrators must also be of the highest calibre. To maintain this standard throughout, we have selected only the very best from within the AV industry to become ProScene Certified Partners.

These rigorously selected partners understand your specific requirements and perhaps as importantly, they have direct access to the specially-trained Optoma support and service teams. Our dedicated experts are available from the initial design and planning phase of a project, right through to the installation stages and beyond. Through our partners, you'll have access to what is probably the most extensive network of service centres across Europe of any projector manufacturer.

Choosing your ProScene projector is just the start. Total support and service excellence are the core of the ProScene ideology, ensuring industry leading dedication to giving you the highest standard of expertise from Optoma and from our certified partners.

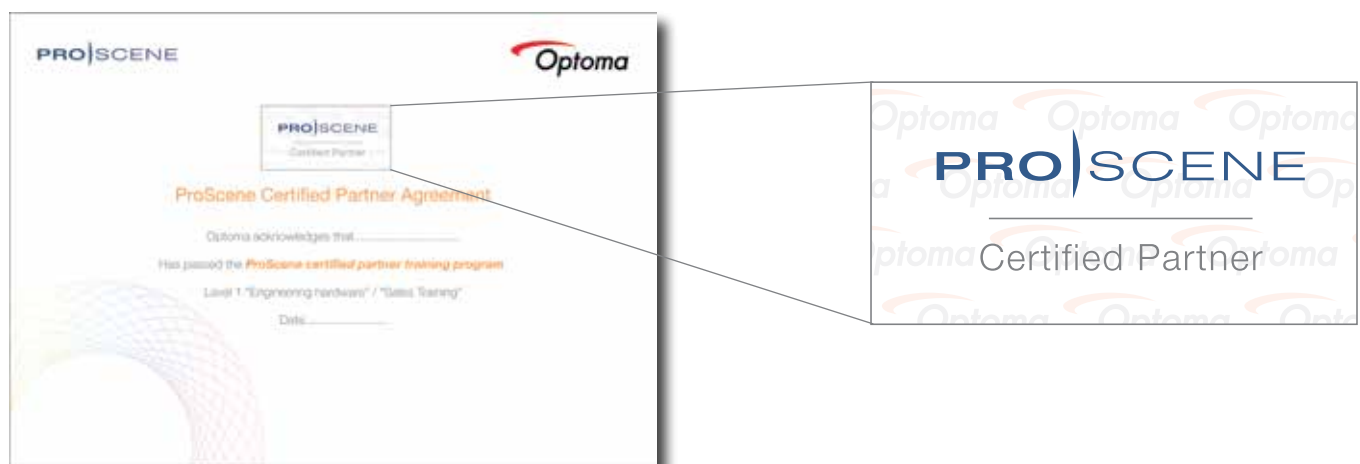

# Features



## **EH7700 features**

-  7500 Lumens, WUXGA Resolution, Dual Lamp
-  360° Installation flexibility - 5x Motorised Lens options and 360° Operation
-  Live performance ready - Mechanical shutter, safety mounting points and flying frame options
-  Ultimate Control - Full support for Crestron, Extron, AMX, PJ-Link and Telnet LAN commands
-  Powerful Image Blending controls - 3-axis colour matching system and 8x lamp-power steps

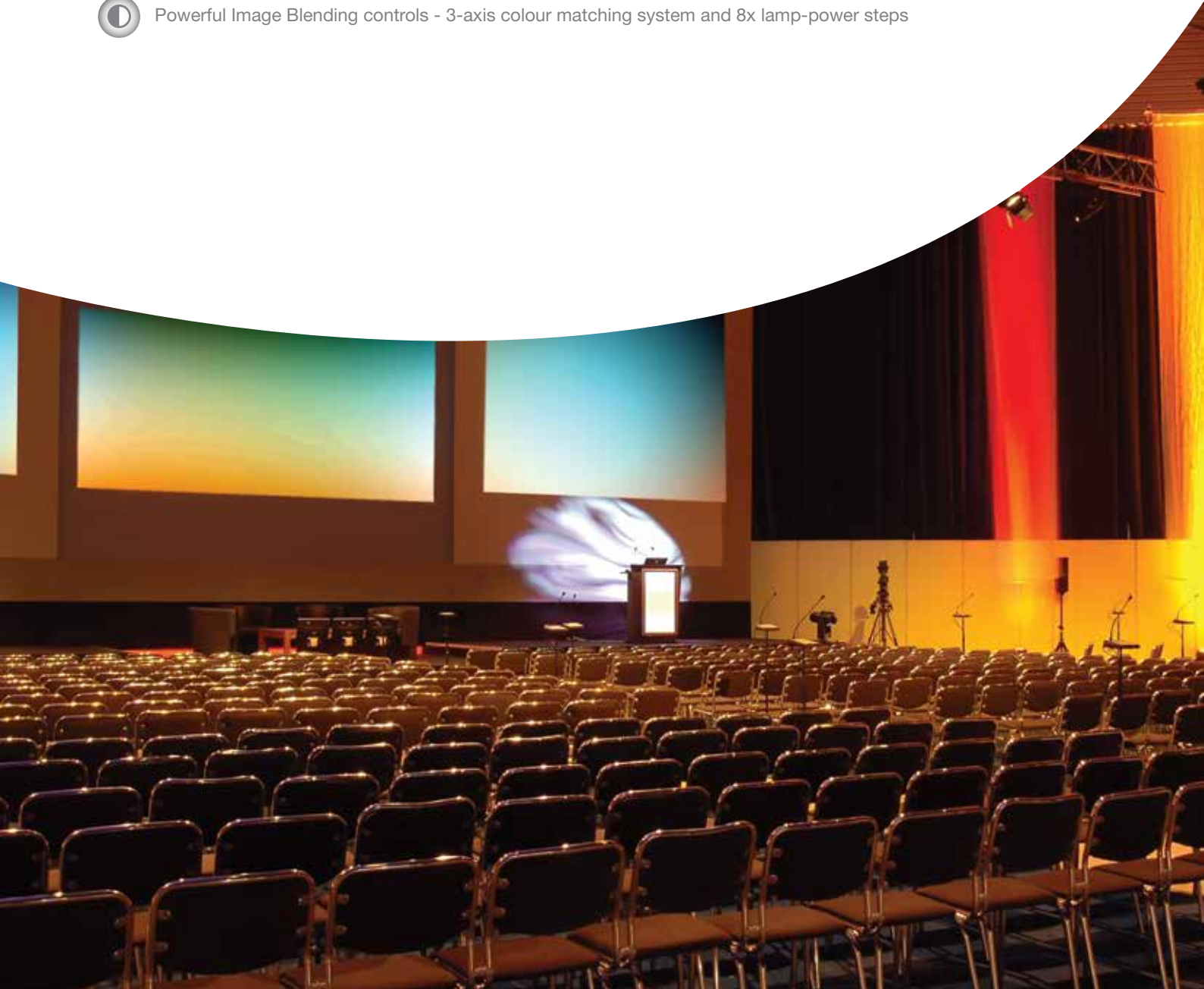

# Image Quality



Superb image quality is at the heart of every ProScene product design. At every step, commencing with the incredibly reliable, high resolution WUXGA DLP® chip, where the image is initially created, via the P-VIP lamp pulsing technology that fine tunes the colour to exacting standards, through to the precision optics to focus the image on a screen, accuracy and integrity of the image are paramount.

ProScene chose DLP® technology for its image quality and unmatched reliability. The reflective nature of DLP® micro-mirror technology provides highly efficient bright images with great contrast whilst maintaining precise colour accuracy and natural, real-world colour reproduction. For demanding professional applications, the proven reliability of DLP® technology makes it the obvious choice.

## P-VIP lamps

The dual Osram 350W P-VIP lamps provide the highest possible luminance, the essential prerequisite of all highly-efficient projectors. These lamps stay brighter for longer, provide a long operating life and a low loss of luminous flux throughout that life. In addition, the lamp drivers are specifically tuned for the lamps, ensuring not only optimum operating conditions for every situation, but also provide sophisticated lamp pulsing modes and the assurance that colour can be fine tuned according to the application.

## Image colour and size control

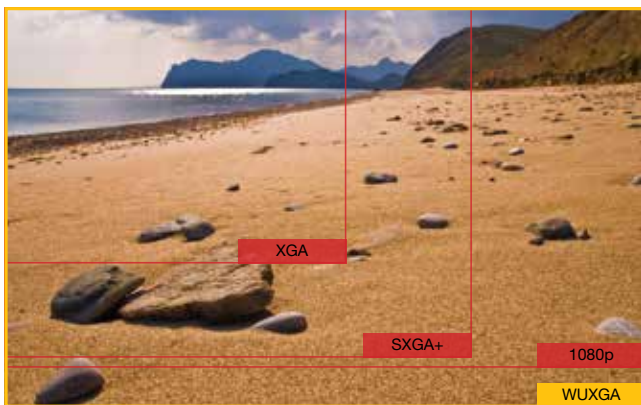

Where detail really matters, the full WUXGA (1920 x 1200) resolution offers 15% more pixels than 1080p and 60% more than SXGA+. This enables unscaled Full HD video and extra detail. Time Code information can be displayed onscreen at the same time, perfect for soundtrack recording & video editing where precise timing can be critical.

## Lamp Pulsing Technology

Advanced lamp-pulsing technologies enable colour performance to be fine tuned directly from the lamp. This unprecedented control helps create vibrant, perfectly saturated colours across the whole light spectrum and produces stunningly natural, life-like images.

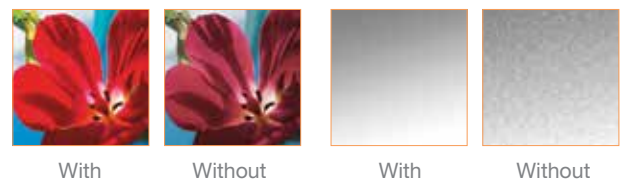
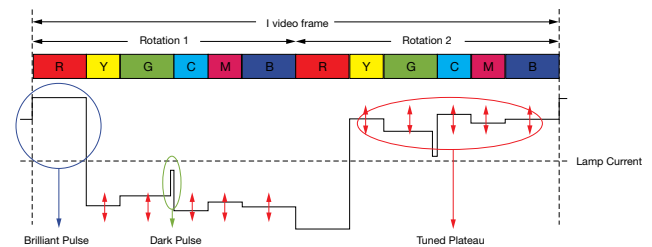

## Amazing Colour

The EH7700 incorporates BrilliantColor™ technology to produce stunningly bright images with perfectly balanced life-like colours.

## Precision Optics

Aspherical optical elements and the use of Low Dispersion (LD) glass maintain optimum sharpness and focus uniformity over the entire image. The ProScene insistence on uncompromising optical quality ensures extremely low colour flare and chromatic aberration resulting in a crystal clear, high contrast image.



# Reliability



All ProScene projectors are designed for continuous 24/7 operation. Only the most reliable, industry proven components are used to ensure superior reliability. This hard-earned “capability” has been meticulously developed over a decade of designing and supporting millions of projectors the world over. The dust-sealed, filter-free design prevents dust and dirt from affecting the system – ensuring optimal image quality with minimal maintenance. ProScene customers can therefore be confident that, as one of the most reliable projector brands in the industry today, Optoma has a reputation for service excellence that is well deserved.



## Dual Lamps

Dual lamps enable a level of reliability simply unavailable with a single lamp projector. Both lamps can be used together to achieve maximum brightness, whilst still providing redundancy should one of the lamps fail. Alternatively a single lamp can be used in Relay Mode to combine the full lifetime of each individual lamp and thereby minimise service intervals.



## Lamp Relay mode

For challenging installations where the EH7700 is run for long periods, the Lamp Relay function can be used to automatically switch between lamps.



## DLP® Technology

DLP® technology from Texas Instruments® is widely recognised and acclaimed for its unmatched reliability and long lasting image performance. When combined with high brightness and native contrast ratios, it becomes the obvious choice for demanding applications. Independent testing has proven DLP® to be the most reliable of projector technologies. Whilst other technologies may show image quality decline after only a few thousand hours, DLP® technology can remain unchanged over hundreds of thousands of hours.

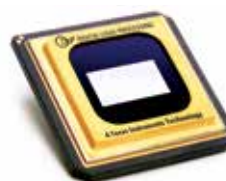

## Total Cost of Ownership

For demanding applications the total cost of ownership of a projector is not in the purchase cost and replacement lamps but in expensive maintenance and service. ProScene projectors require very little maintenance, have no user serviceable parts inside and no filters that require periodic replacement. The result is low cost, predictable service cycles, enabling planned down time to be minimised.

We are so confident that the EH7700 image colour quality will remain as good as the day you bought it that Optoma will guarantee it for five years.



# Flexibility

## Installation Flexibility

To help meet the seemingly limitless challenges of ProAV installations the EH7700 provides 5 lens options with motorised zoom and focus to ensure you can get the image size you require. Motorised lens shift helps you get the image exactly where you want it and the 2 colour wheel options ensure you can match the image quality and brightness exactly to the application's requirements.



There are 5 optional lenses, 4 of which can be easily adjusted via motorised lens-shift, zoom and focus.

## Motorised Lens Shift

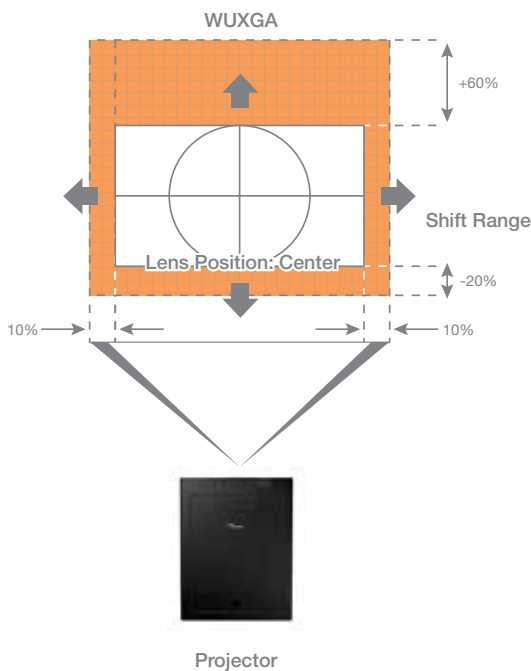

## 360° Projection Capability

Images can be projected over a full 360° range along the vertical axis, including reproduction on a ceiling or floor.



## Picture-in-Picture and Side-by-Side display

Display 2 sources simultaneously with a small inset from the main image or display both sources side by side.

## Interchangeable colour wheels

Two colour wheel options ensure the performance characteristics of the EH7700 can be tailored to match the application. The standard colour wheel maximises brightness whilst ensuring good colour reproduction, whereas the enhanced-colour "video" wheel maximises colour performance and accuracy. The colour wheels are interchangeable modules and can be fitted or exchanged on site without removing the projector cover.



Bright (Standard)



Video (Optional)

## Lens Options

					
<b>Optoma model name</b>	<b>WT1</b>	<b>WT2</b>	<b>ST1</b>	<b>TZ1</b>	<b>TZ2</b>
<b>Throw Ratio</b>	0.78	1.22 ~ 1.47	1.45 ~ 1.95	1.93 ~ 3.71	3.68 ~ 7.04

# Flexibility

## Mechanical Shutter

In situations where only absolute darkness is good enough, the EH7700 has a mechanical shutter to provide total blackout. Perfect for scene changes during live performances.

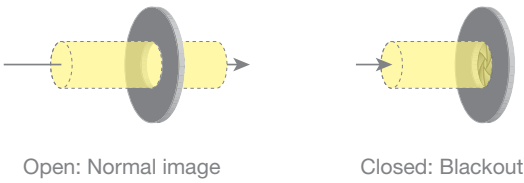

## Edge Blending Controls

No two projectors are completely identical. When performing complex, or even simple edge-blend projects using multiple projectors, it can be difficult to achieve good results if the images do not match. The EH7700 incorporates the following features to ensure high quality and consistent results.

## Colour matching

The EH7700 has a full 3-axis colour matching system, which combined with accurate measurements can create seamless blends every time.

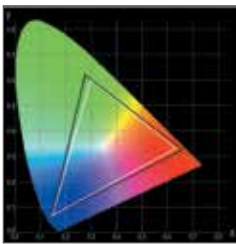

## Brightness matching

The brightness of a projector will vary throughout its life. To correctly match multiple units, the EH7700 has 8x lamp power steps between 80~100% full brightness.



Without



With

## Safety mounting points

To complement the existing ceiling mount, Kensington™ lock and password security features of all ProScene models, the EH7700 benefits from the addition of 2x M8 safety mounting points with supplied eye-bolts.



## Custom ID colours

The EH7700 is available in both Black and White as standard. However if your project calls for a higher level of customisation, the EH7700 is available in any colour from the RAL colour space system.



Please contact your local sales representative for more information.

# Control



## System Integration Control

Multiple EH7700 can be monitored over LAN and also provide the user with an email message alert in case an error occurs or a lamp fails or needs to be replaced, using Crestron Roomview. While the web browser interface and full support for Extron's IP Link, AMX dynamic device discovery and Pj-Link protocols, allow almost all aspects of the EH7700 to be controlled across a network, keeping you in control, wherever you are.

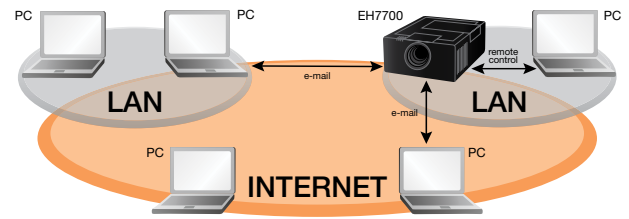
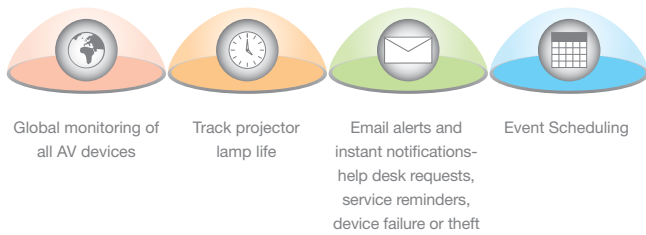

## Ultimate control

Cut up to 30% from your energy bills using 24-hour automated power scheduling to ensure that projectors power off when not in use.



Download Crestron RoomView® Express for free at [www.crestron.com/getroomview](http://www.crestron.com/getroomview)

### Help Alert

Real-time interactive Help Desk requests are sorted to come to the top. The Help Desk then has the ability to respond with an automatic message or instant message the room with exact procedures.

### Display Power

Check on/off status of display power and system power. View a bar graph to monitor the percentage of available projector lamp life and set an alert to notify the services department when a replacement lamp should be ordered before the lamp fails.

### Display Usage

### Schedule Event

RoomView Express makes scheduling of recurring or one time events easy. Setting RoomView to automatically power down at midnight throughout the week can save valuable lamp life and ensure security inside the facility.

### Selected View by Rooms, Attributes or Contacts

RoomView Express gives you the ability to simultaneously view more than 250 rooms from a single screen. Customise RoomView to view by room name, locations and group

### Room Name and Location (sortable)

### Online Status

### Event Log

Automatically generates log files, reports and charts to analyze ROI and budget allocation. Track device usage, call statistics and user history.





### Projector Power



# Lenses



## Lens Options

					
Optoma model name	WT1	WT2	ST0/ST1	TZ1	TZ2
Focal Length (f) (mm)	11.73	18.1 ~ 21.72	21.5 ~ 28.7	28.6 ~ 54.33	54.06 ~ 102.7
F number	2.2	2.0 ~ 2.3	2.0 ~ 2.3	2.2 ~ 3.0	2.3 ~ 3.16
Zoom Range (Ratio)	Fixed	1.2x	1.33x	1.9x	1.9x
Zoom & Focus Adjustment	Fixed	Motorized			
Throw Ratio	0.78	1.22 ~ 1.47	1.45 ~ 1.95	1.93 ~ 3.71	3.68 ~ 7.04
Throw Distance (m)	0.5 ~ 8.4	0.79 ~ 15.8	0.94 ~ 21.0	1.25 ~ 40.0	2.38 ~ 75.8
Throw Distance (feet)	1.65 ~ 27.6	2.59 ~ 51.9	3.07 ~ 68.9	4.09 ~ 131.1	7.8 ~ 248.7
Projection Image Size	30" ~ 500" inches				
Motorized Lens Shift	Fixed	Horizontal: + / - 10% offset Vertical: - 20% ~ + 60% offset			

## Throw Distance Chart

EH7700 Throw Distance									
Diagonal Image Size	WT1	WT2		ST0 / ST1		TZ1		TZ2	
	Fixed (m)	Min (m)	Max (m)	Min (m)	Max (m)	Min (m)	Max (m)	Min (m)	Max (m)
50"	0.84	1.3	1.58	1.56	2.1	2.08	4.0	3.97	7.58
60"	1.01	1.56	1.9	1.87	2.52	2.49	4.8	4.76	9.1
70"	1.18	1.82	2.20	2.19	2.94	2.91	5.59	5.55	10.61
80"	1.35	2.08	2.53	2.5	3.36	3.33	6.39	6.34	12.13
100"	1.68	2.61	3.16	3.12	4.2	4.16	7.99	7.95	15.16
150"	2.52	3.91	4.75	4.68	6.3	6.24	11.99	11.89	22.75
200"	3.36	5.21	6.33	6.25	8.4	8.32	15.98	15.86	30.33
250"	4.2	6.52	7.92	7.81	10.5	10.39	19.98	19.82	37.91
300"	5.04	7.82	9.5	9.37	12.6	12.47	23.97	23.78	45.49

For guide purposes only

## Eco Friendly

Cut up to 30% from your energy bills using 24-hour automated power scheduling to ensure that projectors power off when not in use.



### Direct Power On

The projector will start up instantly when power is supplied to the Unit. This eliminates the need to manually turn on the projector via the remote control or the keypad, ideal for use in rooms with a “master” power switch.



### Signal Power On

The projector will power on when it receives a signal through one of the PC/video inputs. This ensures that the projector is only switched on when it is needed.



### Auto Power Off

If after a pre-determined time the projector does not receive a signal, it will turn itself off automatically, conserving power and extending the life of the lamp.



### Eco Standby Mode

Reduces energy consumption to less than 0.5W when the projector is not in use.



We know that improving our products is the best way to reduce our impact on the environment. That's why at Optoma, we design our products to have a long usable life, use fewer materials, ship with the minimum packaging and be free of all possible toxic substances. Naturally, energy efficiency and being recyclable are built in at the design stage. With each new product, we strive towards minimising our environmental impact. For full details of Optoma Project Green please visit our website.

# Dimensions

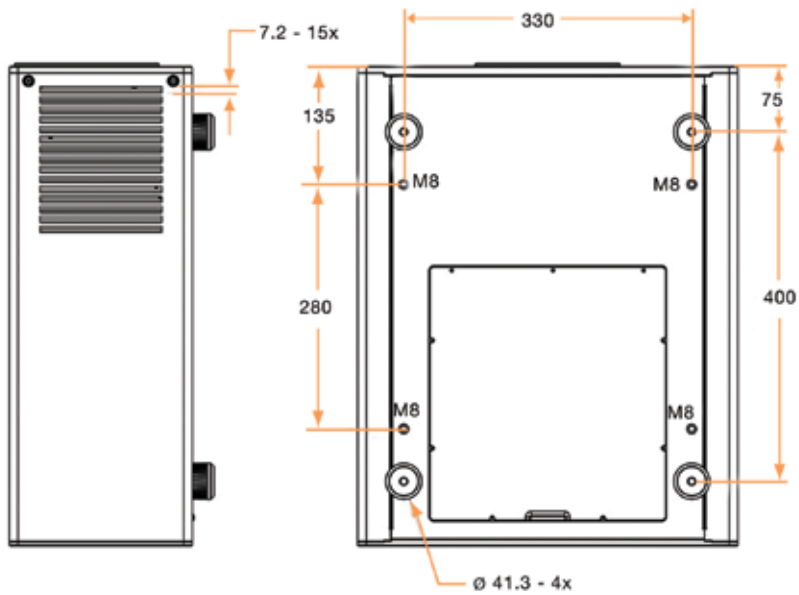
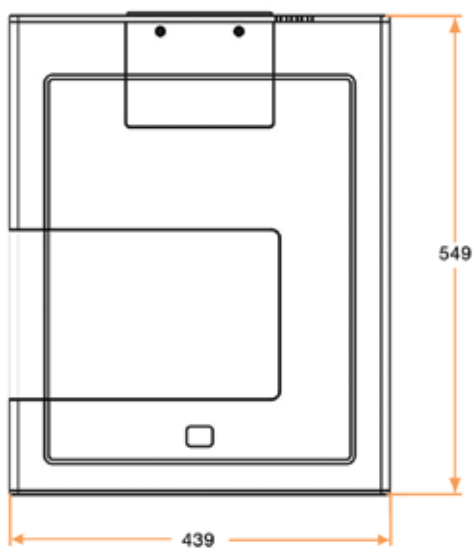
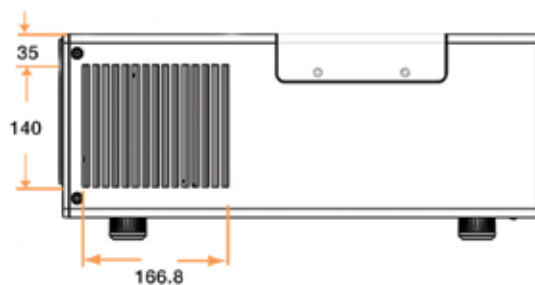
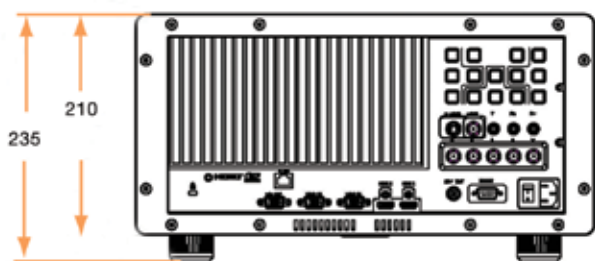

All measurements are in mm

# Labelling

## Easy to use remote control

- 1 Power On
- 2 Mechanical Shutter
- 3 Function 2 (user assigned)
- 4 Display Mode
- 5 Freeze
- 6 Lens Zoom +/-
- 7 Remote ID (All)
- 8 HDMI 2
- 9 HDMI 1
- 10 DVI (dependent on model)
- 11 Information Panel
- 12 Re-Sync
- 13 Video
- 14 YPbPr
- 15 Numbered keypad (for remote ID / security input)
- 16 Power Off
- 17 Test Pattern
- 18 Function 1 (user assigned)
- 19 Enter/Help (user assignable)
- 20 Four Directional Select Keys
- 21 Menu
- 22 Lens Shift
- 23 Format (Image Aspect Ratio)
- 24 Lens Focus +/-
- 25 Remote ID
- 26 VGA 1
- 27 S-Video
- 28 VGA 2
- 29 BNC

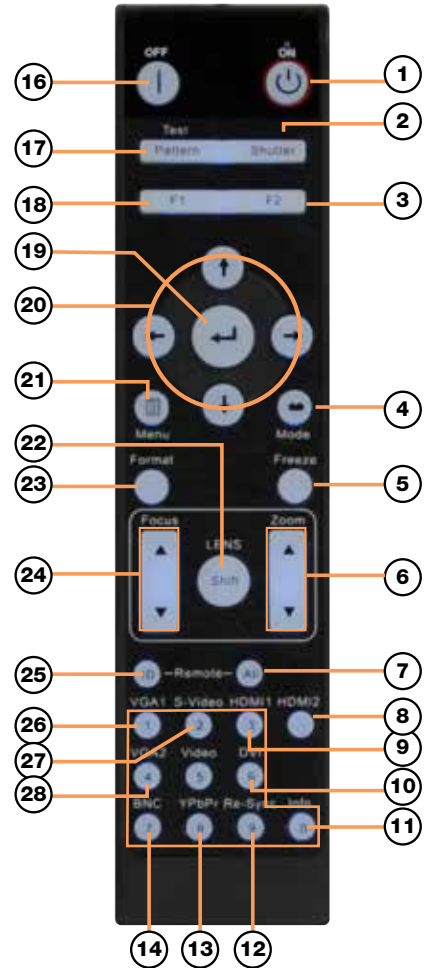

## Input/Output Connections

- 30 S-Video
- 31 Composite Video (CVBS via BNC)
- 32 Component Video (YPbPr)
- 33 BNC (YPbPr/RGBHV)
- 34 Kensington™ Lock Port
- 35 RJ-45
- 36 Wired Remote (3.5mm)
- 37 VGA-Out (Monitor Loop-through)
- 38 VGA2-In (YPbPr via adapter)
- 39 VGA1-In (YPbPr via adapter)
- 40 HDMI 1
- 41 HDMI 2
- 42 +12V Trigger (3.5mm, 250mA)
- 43 RS-232 (9-pin D-Sub)
- 44 Power Switch
- 45 Power Socket

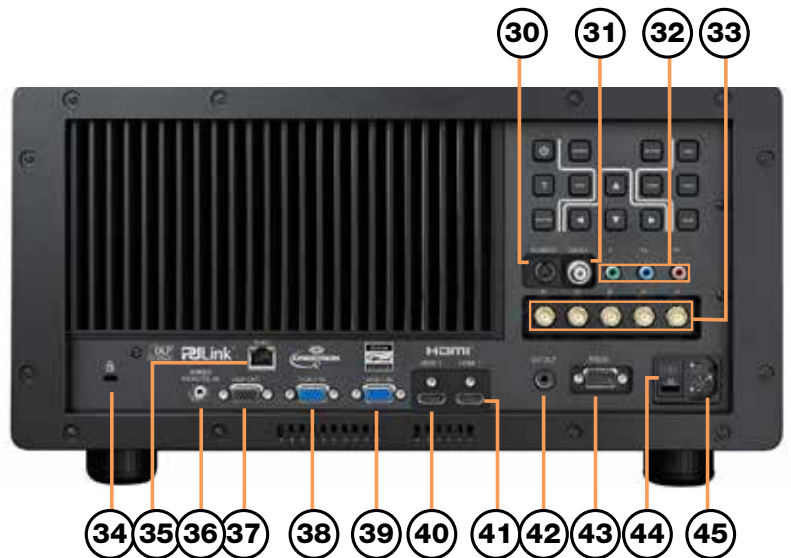

## Keypad

- 46 Power
- 47 Source
- 48 Re-Sync
- 49 Lens Shift
- 50 Info
- 51 Menu
- 52 Enter
- 53 Focus
- 54 Shutter
- 55 Control Keys
- 56 Zoom



# Technical Specifications



Projector		DLPTM Technology by Texas Instruments
	Technology	0.67" WUXGA, DC3, Type A chip
	Resolution	Native WUXGA (1920 x 1200)
	Brightness - Dual Lamp	7000 ANSI lumens / 7500 centre lumens using "Bright" colour wheel
	Aspect Ratio	16:10 native, 4:3 & 16:9 compatible
	Refresh Rate	15kHz to 100kHz / 25Hz to 85Hz
	Contrast	5000:1
	Video Compatibility	PAL (625/576i/p), SECAM, NTSC (525/480i/p), HDTV (720p, 1080i, 1080p)
Optics		
	Lamp Type	2x 350W P-VIP
	Lamp Life	2000 hr bright mode / 2500 hr ECO mode (5000 hr ECO relay mode)
	Colour Wheel Options	Bright wheel 6 Segment RGBCYW (standard) Video wheel 6 Segment RGBCYM (optional)
	Shutter	Mechanical
	Lens Shift	Motorised lens shift, focus and zoom (+60% -20% V, ±10% H)
	<b>Lenses (no lens supplied as standard)</b>	
	WT1	Short throw 0.78 (Fixed)
	WT2	Wide 1.22~1.47 (1.2x zoom)
	ST0	Standard 1.45~1.95 (1.33x zoom)
	ST1	High quality 1.45~1.95 (1.33x zoom)
	TZ1	Long 1.93~3.71 (1.9x zoom)
	TZ2	Extra long 3.68~7.04 (1.9x zoom)
	Keystone Correction	Vertical ±20°
	Uniformity	95% (centre)
Connectivity		
	Inputs	2 x HDMI (with locking screw) BNC (RGBHV) PC RGB 2 x 15 Pin D-Sub VGA Component 3RCA S-Video/Composite 4 pin Mini DIN / RCA
	Output	PC (monitor loop-through) VGA Out +12V trigger (3.5mm jack)
	Control and Communication	RS232 9pin D-SUB RJ45 (Crestron/Extron/PJ-Link/Telnet) Wired Remote (3.5mm jack)
General		
	Noise Level	39dB
	Weight	24Kg (without lens)
	Dimensions (W x D x H)	439 x 549 x 235mm
	Power Requirements	100 – 240V AC @ 50 – 60Hz
	Power Consumption	907w bright mode < 0.5w standby mode
	Heat Dissipation	3416 BTU/hr.
	Operating Conditions	730w ECO mode < 0.5w standby mode 5 ~ 40°C, max. humidity 85%, max. altitude 3000m
	Portrait mode <sup>1</sup>	Not supported
	360° Operation	Yes (Around horizontal axis)
	Operating Temperature	0 ~ 750m, 5 ~ 40°C 750m ~ 1500m, 5 ~ 35°C 1500 ~ 3000m, 5 ~ 30°C
	Environmental	RoHS and WEEE
	Conformances	CE, TUV-GS, CB
	Security	4-digit PIN code Kensington Lock port 2x M8 Safety Mounting Points (Eye Bolts supplied)
	Warranties	3 Years
Supplied Accessories		
	Cables	VGA cable AC power cord
	Other	Infra-red remote control (selectable IR code sets for controlling multiple units) Batteries x 2 User manual CD Quick start card Warranty card WEEE card

# Accessories

## Flying Frame EH7700

Part Nr: P5640

The safest way for handling a projector in rental & staging applications is by using it in combination with a flying frame. The projector is fitted on a bottom frame that is adjustable in 3 axes, allowing the projector to be aligned on screens with high accuracy.

This frame can be used in combination with a second frame and projector for applications requiring multiple units eg. Passive 3D Installations.. The stack frame has mounting holes for truss hooks or chains. A projector mount (**392311b**) is necessary to fix the projector to the stack frame (4 x M8).



## Short Ceiling Mount

Part Nr: 390065b

The universal ceiling mount 390065b is a rigid and strong ceiling mount suited for suspending EH7700 or EX855 and EW865 projectors from the ceiling.

- Maximum load 70 Kg
- Standard equipped with the patented ball-joint.
- Maximum adjustment angle 20 degrees
- Fixed length of 165 mm
- Mounting pattern 90 x 90 mm suited for EH7700 and EX855/ EW865 projector mounts



## Long Ceiling Mount

Part Nr: 390061b

The universal ceiling mount 390061b is a rigid and strong ceiling mount suited for suspending EH7700 or EX855 and EW865 projectors from the ceiling.

- Maximum load 70 Kg
- Standard equipped with the patented ball-joint
- Maximum adjustment angle 20 degrees
- Adjustable between 700-940 mm
- Mounting pattern 90 x 90 mm suited for EH7700 and EX855/ EW865 projector mounts



## Projector Base Plate

Part Nr: 392311b for EH7700

Part Nr: 392315b for EX855/EW865

The above will need a projector base plate, EH7700 (392311b) and the EX855/EW865 (392315b).

Both base plates use 4 x M8 screws to attach your projector and the ceiling mount plate uses 4 x M6.



## Accessories Continued

### 17990 Flight Case EH7700

Heavy Duty flight case with wheels and handles and can also carry two extra lens plus space for cables and remote.

- Part Number: 17990
- Weight 32Kg
- Shipping dimensions 930 x 555 x 445mm



# Accessories Continued

## Optimised edge blending (Available direct from Optoma)

Optoma have worked in partnership with Calibre to produce special versions of Calibre's edge blending and warping products optimised for use with our ProScene projectors. This unique collaboration significantly reduces the complexity and configuration time required to edge blend multiple ProScene projectors and is covered by the industry leading ProScene technical support services should you require assistance with your edge blending project.



### HQView320 HQT™ Scaler with Warp and Edge Blend

Best in class professional image processing in a compact affordable module.



### HQView325 HQT™ Scaler with Warp Mapping Edge Blend & HDMI/DVI In/Out

HQView325 features 4-sided soft edge blend with multi-region black level correction for seamless blending of multiple projectors.



### HQView520 Universal HQT™ Scaler-Switcher-Scan Converter with Warp, Edge Blend & 3G-SDI In/Out

Use as a routing switcher and universal interface for 3G-SDI, HD-SDI, DVI or HDMI



### HQView530 LED Screen HQT™ Scaler-Switcher with 3G-SDI

LEDView530 is a highly flexible LED video screen image scaler which provides stunning image quality for professional, broadcast, sports, digital signage & corporate AV.







## Worldwide technical and commercial support

### Optoma Europe

#### Optoma Europe Ltd.

42 Caxton Way  
The Watford Business Park  
Watford  
Hertfordshire  
WD18 8QZ  
UK  
Tel: +44 (0) 1923 691 800  
Fax: +44 (0) 1923 691 888

#### Optoma Deutschland GmbH

WIESENSTRASSE 21  
D40549 Düsseldorf  
Germany  
Tel: +49 (0) 211 506 6670  
Fax: +49 (0) 211 506 66799

#### Optoma France

Batiment E  
81-83 avenue Edouard Vaillant  
92100 Boulogne Billancourt  
France  
Tel: +33 (0) 1 41 46 12 20  
Fax: +33 (0) 1 41 46 94 35

#### Optoma Spain

C/ José Hierro, 36 Of. 1C  
28529 Rivas VaciaMadrid  
Madrid  
Spain  
Tel: +34 91 499 06 06  
Fax: +34 91 670 08 32

#### Optoma Benelux

Optoma Benelux BV  
Randstad 22-123  
1316 BW Almere  
The Netherlands  
T: +31 (0) 36 820 0252  
F: +31 (0) 36 548 9052

#### Local Representatives

Turkey

UAE

Poland

Russia

Italy

### Optoma Scandinavia

#### Optoma Scandinavia

Lerpeveien 25  
Postboks 9515 Åskollen  
3038 Drammen  
Norway  
Tel: +47 32 98 89 90  
Fax: +47 32 98 89 99

### Optoma USA

#### Optoma USA Headquarters

3178 Laurelview Ct.  
Fremont, CA 94538  
Tel: (510) 897-8600  
Fax: (510) 897-8601

#### Atlanta Sales Office

7000 Central Park NE, Suite 570,  
Atlanta, GA 30328  
Tel: (678) 281-2228  
Fax: (770) 399-3035

#### Canadian Sales Office

2420 Meadowpine Blvd, Suite 105,  
Mississauga, ON L5N 6S2, CANADA  
Tel: (905) 285-0685

### Optoma Asia

#### Taiwan

Optoma Corporation  
Taipei Office  
5F., No. 108, Minchiuan Rd., Shindian City,  
Taipei Taiwan 231, R.O.C.  
Tel: +886-2-2218-2360  
Fax: +886-2-2218-2313  
<http://www.optoma.com.tw>

#### Taichung Office

7F-5, No.3, Lane 2, 1st Rd, Taichung Industrial  
Park, Xitun Dist., Taichung City, 40767, Taiwan,  
R.O.C.  
Tel: +886-4-3505-0336  
Fax: +886-4-3505-0338

#### Kaohsiung Office

Rm. D, 7F, No.108, Zhonghua 3rd Rd., Qianjin  
Dist., Kaohsiung City 80145, Taiwan, R.O.C.  
Tel: +886-7-952-5689  
Fax: +886-7-241-2197

### China

Shanghai Office  
5F, No. 1205 Kaixuan Road, Changning  
District, Shanghai  
Tel: +86-21-6294-7376  
Fax: +86-21-6294-7375  
<http://www.optoma.com.cn>

#### Beijing Office

20D apartment 3, Build No.3, Yindu Tower, No  
48 ZhiChun road, HaiDian district, Beijing  
Tel: +86-10-5873-1919  
Fax: +86-10-5873-1919 \*8018

#### ShenYang Office

Room1201, building C3, Wulihe Tower, No 4-1  
WenTi road, HePing district, ShenYang  
Tel: +86-024-3188-7018  
Fax: +86-024-3188-7018-808

#### Xi'an Office

Room 1310, building B, ShiMao tower,  
GuanDongZheng street, Xi'an  
Tel: +86-029-8228-2428  
Fax: +86-029-8228-2428

#### GungZhou Office

Room 602, NanTie Tower, No.57  
No.1ZhongShan road, YueXiu district,  
GungZhou  
Tel: +86-20-6128-0990 / 6128-1025  
Fax: +86-20-6128-1027

#### ChongQing Office

Room 9-2, building 19 HuaYuMingDu,  
ShiQiaoPu, ChongQing  
Tel: +86-23-6879-7626  
Fax: +86-23-6879-7725

#### ChengDu Office

Room A3 floor 20, building A Time digital  
square, No.1 South RenMin road, ChengDu  
Tel: +86-28-8523-1553 / 8631-7092

#### Hong Kong Office

Unit A, 27/F., Dragon Centre, 79 Wing Hong  
Street, Cheung Sha Wan, Kowloon, Hong Kong  
Tel: +852-2396-8968  
Fax: +852-2370-1222  
<http://www.optoma.com.hk>



**Optoma Europe Ltd.**  
42 Caxton Way, Watford Business Park, Watford, Hertfordshire, UK. WD18 8QZ  
[www.optoma.co.uk](http://www.optoma.co.uk)



<sup>1</sup>Restrictions may apply, please check the Optoma website for more information. Brightness and lamp lifetime will vary depending on selected projector mode, environmental conditions and usage. As is common with all lamp based projectors, brightness will decrease over the lamp lifetime. Typical lamp life achieved through testing. Will vary according to operational use and environmental conditions. Optoma guarantees that in normal use, Optoma DLP® colour quality will be indistinguishable from when new. Exclusions: (a) Guarantee is voided if the projector is subject to damage through misuse. (b) Guarantee may be void in industrial or commercial entertainment environments where dust or smoke is excessive (c) Guarantee will not apply if lamp brightness is below 50% due to wear or if the projector is not working due to other faults. (d) Over time worn lamps within all projector types will show a slight colour variance. Copyright © 2011, Optoma Europe Ltd. All other product names and company names used herein are for identification purposes only and may be trademarks or registered trademarks of their respective owners. Crestron®, the Crestron and RoomView® logo are registered trademarks of Crestron Electronics, Inc. Errors and omissions excepted, all specifications are subject to change without notice. DLP®, BrilliantColor™ and the DLP logo are registered trademarks of Texas Instruments. All images of products are for representation purposes only. Whilst every care is taken to provide accurate images of our products, actual products may differ slightly. Some product images may have been digitally altered by us to add an Optoma logo to the front panel. Optoma reserves the right to amend or alter actual product or product images without notice. Some images may be simulated.