

**MITSUBISHI
ELECTRIC**
HOME THEATER PROJECTOR

■ Specifications

Model		HC4000	
Projection system		DLP™ system	
Panel specs	Panel size	0.65 DMD, Aspect ratio 16:9	
	Number of pixels	1920x1080	
	Drive system	DMD reflection system	
Array		Stripe pattern	
Optical specs	Lens	Zoom / focus operation*1	
	f (mm)*1	1.5x manual zoom / manual operation	
	Light source lamp	20.6-30.1	
Optical system		230W (at standard mode), 190W (at low mode)	
Color wheel		Time-division color separation / composition system	
Projection screen size (inches)		6 segment (RGB RGB), 4x	
Images	Brightness (lm) ¹⁺²		50-300
	Contrast ratio*1		1300 (Max)
	Resolution	PC input	3600:1
	Scan frequency		VGA 640x480 - UXGA1600x1200, 1920x1080
Input signal system	Video	15-80	
	PC	50-85	
Input	Video	NTSC, NTSC4.43, PAL (including PAL-M and N), SECAM, PAL-60	
	PC	Video input: 480i/p, 576i/p, 1080i 60/50, 1080p 60/50/24, 720p 60/50	
	PC input	Mini D-Sub 15 pin	PC/AT compatibles, Mac, PC98
	HDMI input	HDMI terminal	1 terminal
	Composites	RCA terminal	1 terminal (Ver.1.3, Deep color)
	S	S-Video terminal	1 terminal
Functions	Components	RCA terminal	1 terminal (component can be also input to Mini D-Sub 15 pin)
	Serial	1 terminal (Mini DIN 8 pin, RS-232C follow)	
	Gamma mode	3 patterns + 2 users	
	Digital keystone (Vertical)	±15 steps	
Power source voltage	AC100V 50/60Hz		
Power consumption (W)	340 (at waiting 0.4W)		
Weight (kg / lbs)	3.6 / 7.9		
Main unit dimensions (WxDxH)	345x129x270mm / 13.6"x5.1x10.6" (excluding height adjustment)		
Other	Supplied accessories		Power source cord (1.8m), Remote control, AA batteries (x2), RGB signal cable, Lens cap, Lamp replacement attachment

*1 Varies depending on conditions. *2 All brand names and product names are trademarks, registered trademarks or trade names of their respective holders. Lamp life specification is an estimate based on verification under proper conditions and is not the duration of the warranty. Lamp will shut-off automatically when usage reaches the specified estimated maximum lamp hours. Service life may vary widely depending on usage and operating environment and conditions, as well as users' adherence to the maintenance and cleaning procedures provided in the user manual.

■ Terminals



■ Option



for a greener tomorrow

Eco Changes is the Mitsubishi Electric Group's environmental statement, and expresses the Group's stance on environmental management. Through a wide range of businesses, we are helping contribute to the realization of a sustainable society.

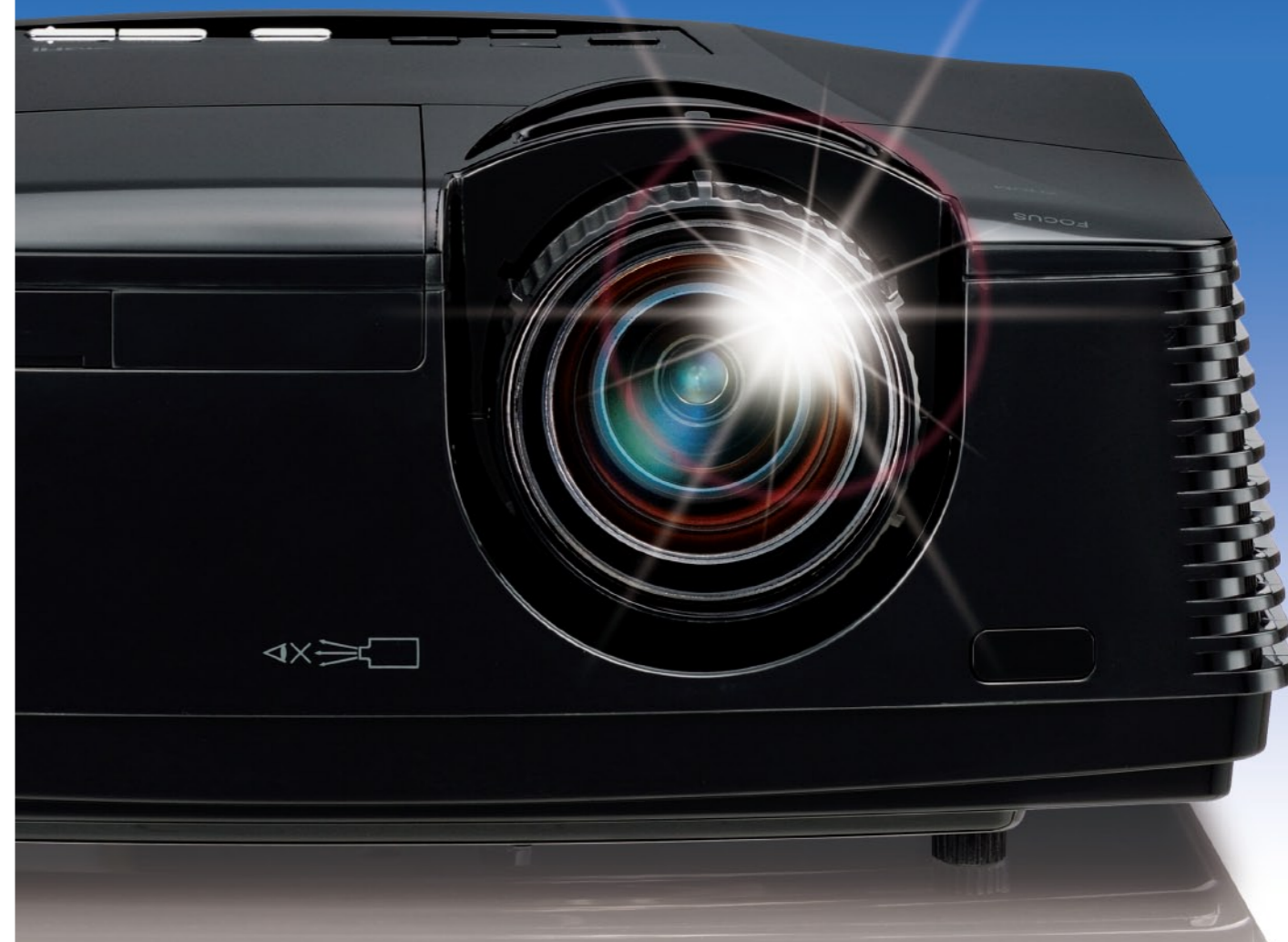

Newly Improved Full High-definition Performance

New **HC4000** 

To find out more about HC4000 and our projectors, visit us at

 **MITSUBISHI ELECTRIC EUROPE (BENELUX Office)**

Nijverheidsweg 23A, 3641 RP Mijdrecht - The Netherlands
Tel: +31 (0)297-282461 Fax: +31 (0)297-283936 - www.MitsubishiElectric.nl

for a greener tomorrow 



Movies, TV programs, games and more Enjoy it all in high-definition on 100"+ screens

Imagine it... Hi-Vision technology bringing you hours of viewing pleasure in the comfort of your own home. Easy to set-up and operate – the HC4000 reproduces beautiful, high-definition (HD) imagery, bringing movies and TV programs to life with vivid, sharp colors, and adding new meaning to the word “excitement” when playing games. Enjoy it all on a large 100"+ screen while relaxing on your living room sofa.

Finally, an affordable full-HD projector that spares nothing to ensure a new dimension in viewing pleasure. An amazing level of beauty and excitement you need to experience with your own eyes.

FULL HD 1080

HDMI HIGH DEFINITION MULTIMEDIA INTERFACE

HOME THEATER PROJECTOR
New HC4000



Illuminated remote control unit

High-performance 0.65-in DLP™ DarkChip3™

A key feature of the HC4000 is the latest Digital Light Processing (DLP™) chip incorporating a new digital micromirror device (DMD) comprised of densely embedded micromirrors. A smaller mirror cavity diameter and narrower gaps between the mirrors improve the aperture ratio of the innovative chip, and reflective light diffusion has been greatly reduced by improving the wiring below the mirror section. The mirrors are controlled to tilt repeatedly several thousand times per second, enabling smooth, true reproduction of the digital source into finely detailed images with no noise or deterioration.

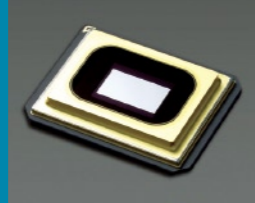

Digital Micro-Mirror Device

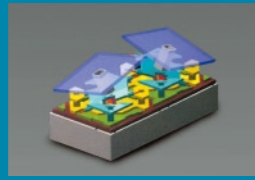

DMD Pixel Composition Map

DDP3021 Full 10-bit Panel Driver

The built-in DDP3021 full 10-bit panel driver produces approximately four times the gradation of 8-bit models, providing smooth expression of dark gradation subtleties.

Blu-ray 24P direct output compatible

Capable of handling an output of 48P, twice the speed of cinema film (24 frames per second). This precise timing ensures true-to-life reproduction with original, smooth movement.

2-3 Pull-down
At the time of converting 24 frames per second into 60 frames per second, when lining up the second and third frames in sequence, there is a surplus third B frame, which deteriorates movement smoothness.

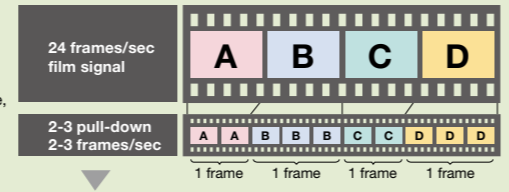

24P direct output
With 24P direct output, the 24 frames per second is converted a full order to a 48 frames per second. This allows sequential matching of two frames at a time, thereby enabling image reproduction with the original smoothness.

Richer, More True-to-life Colors

The HC4000 is equipped with a six-segment color wheel capable of reproducing a standard illumination at the color temperature of D65 (6.5 million). Signals from video sources are reproduced with more true-to-life colors and richer gradation.

Color Management for Preferred Color Adjustment

Adjust images to your color preferences. R (red), G (green), B (blue), C (cyan), M (magenta), and Y (yellow) can each be individually adjusted with the built-in color management function.



Before adjustment

After adjustment

Anamorphic Lens Compatibility - Choose Setting Based on Media Played

The anamorphic lens compatibility of the HC4000 widens the projection range of cinema-scope images. Mode 1 proves extended projection, and Mode 2 is for images other than cinema-scope, which mirror the original with the anamorphic lens attached.

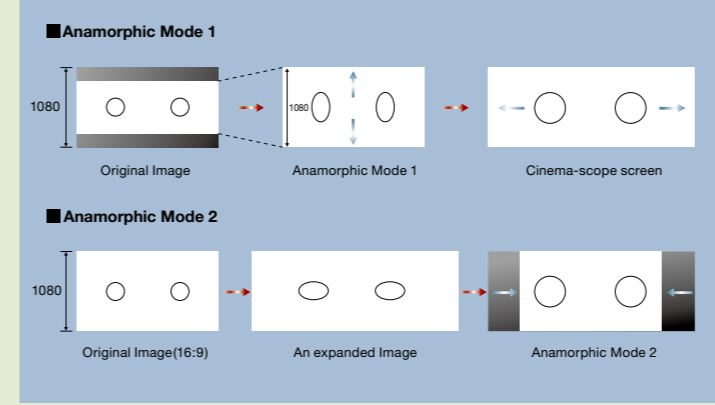

BrilliantColor™

A new color processing algorithm and improvements in system-level color signal picture quality enable accurate reproduction of many mid-range colors in video and natural scenery.

Adjustable Overscan

For images such as DVD sources, the overscan ratio can be varied between 90 and 100% in 1% intervals when HDMI/components are connected.

One-touch projection

The projector power switch and electric screen (roll down/retract) control are linked, providing a convenient one-touch operation trigger.

Screen Distortion Correction

Correct screen distortion using the shape distortion correction function for digital models. Vertical distortion correction of ±15 steps (1 step approximately 1°) is possible.

1300lm brightness, 3600:1 native contrast

A fixed iris is adopted, realizing both enhanced brightness and contrast for images. Even in a relatively bright living room with the curtains closed, movies, sports, high-definition broadcasts, and Blu-ray sources can be enjoyed in crystal-clear high-definition.

Full High-definition, all-glass 1.5x Short-throw Zoom Lens

A newly developed short-throw zoom lens has been adopted for the HC4000. The 4-cluster, 13-piece all-glass lens provides excellent focusing performance with 1.5x magnification of high-definition images. Improvements in image depth and the lens aperture make it possible for deep blacks to be expressed.



High-output, Long-life Lamp & Quiet performance

The light source is a 230W high-output lamp capable of a long estimated lifetime of up to 5000 hours when operating in low mode. The low-noise fan is specially designed for cooling efficiency taking factors such as fan and color wheel shape into consideration, ensuring an impressively low 25dB quietness when operating in low mode.



Projection Distance

Screen size (16:9)			Hd (cm)	Projection distance(L)	
Diagonal (inch)	Width(W) (cm)	Height(H) (cm)		Shortest (Wide) (m)	Longest (Tele) (m)
50	111	62	21	1.5	2.3
60	133	75	25	1.8	2.7
70	155	87	29	2.1	3.2
80	177	100	34	2.4	3.6
90	199	112	38	2.7	4.1
100	221	125	42	3.1	4.6
110	244	137	46	3.4	5.0
120	266	149	50	3.7	5.5
150	332	187	63	4.6	6.9
200	443	249	84	6.2	9.2
250	553	311	105	7.7	11.5
300	664	374	126	9.3	-

Projection Installation

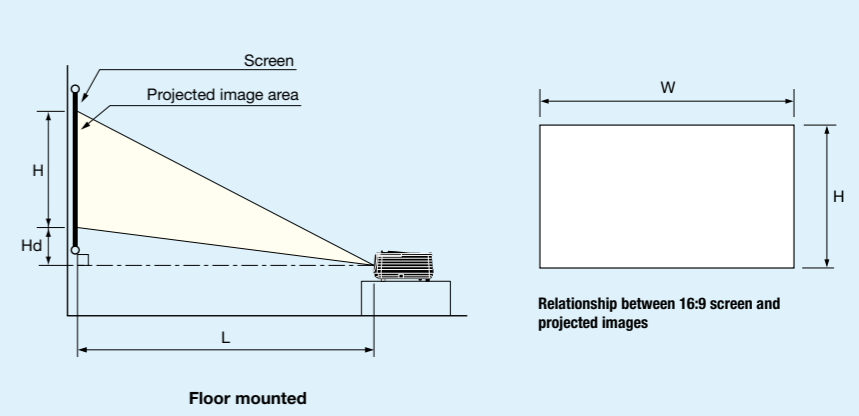

Relationship between 16:9 screen and projected images

Floor mounted