

SONY

make.believe

VPL-E Series Data Projectors



BrightEra

Eco-friendly, Good TCO, and Easy Operation

The VPL-E Series is an Excellent Choice for Education or Business

Sony's VPL-E Series data projectors are designed to deliver a low total cost of ownership, and include eco-friendly features, thanks to a long-lasting lamp design and low power consumption.

These projectors are not only stylish but also offer native XGA resolution for high image quality with a high brightness of 3600 lumens (VPL-EX175), 3100 lumens (VPL-EX145), 2600 lumens (VPL-EX120), or 2300 lumens (VPL-EX100).

Delivering superb images and simple operation, Sony's VPL-E Series projectors provide an excellent balance between quality and cost, ideal for use in education or business.



FEATURES

Cost-efficient, Energy-efficient Design

Long-lasting Lamp

By incorporating a newly developed high-performance lamp and advanced lamp-control technology, VPL-E Series projectors deliver an extremely long lamp replacement time of 6,000 hours*.

* Approximate recommended period, in low mode.

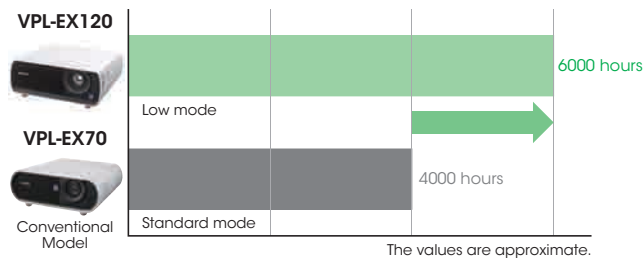

Longer Lamp Exchange Time

Lamp and Filter Synchronized Maintenance

When it's time to clean the air filter, a reminder message is clearly displayed on screen. Like the lamp, the air filter has an approximate 6,000-hour cleaning cycle. Users can therefore replace both the lamp and the filter at the same time, saving maintenance effort and cost.

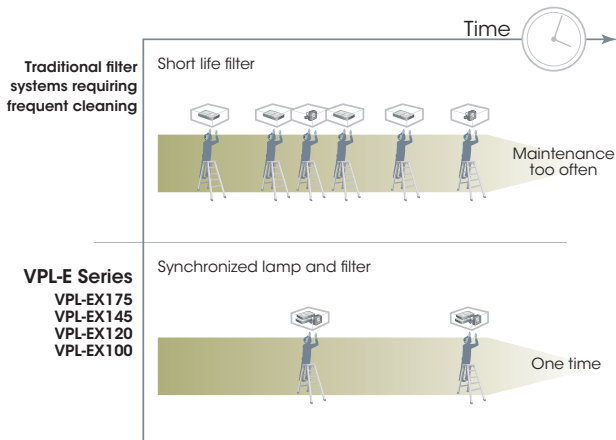

Maintenance Cycle Comparison Image

ECO MODE Button

With a single push of the ECO MODE button on either the projector or the supplied Remote Commander™ unit, users can switch to the ECO setting.

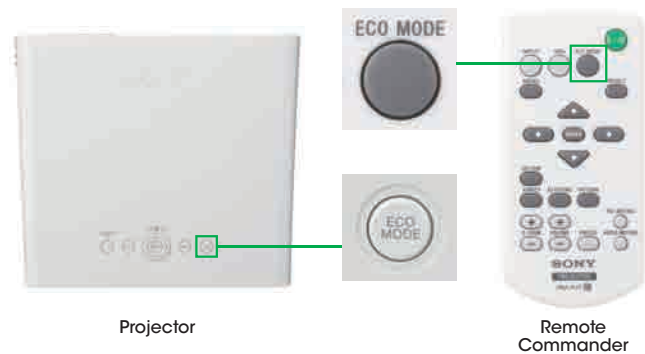

ECO MODE Button

	High	Standard	ECO setting
Lamp Mode			Low
Power Saving Mode	Off	Lamp-Off	Standby
Standby Mode	Standard		Low

ECO MODE Menu

Power Saving Mode

If no signal is input for 10 minutes, the projector lamp will automatically turn off.

Low Power Consumption

The VPL-E Series offers remarkably low power consumption, allowing users to make significant savings on their electricity expenses.

Simple Projector Replacement

The standard 1.3x zoom lens enables installation flexibility when replacing an existing projector with the VPL-E Series. There's no need to change ceiling mount positions.

High Picture Quality

High Picture Quality and Bright Images

By combining a new generation of inorganic LCD panels that utilize Sony's BrightEra™ technology with a 3LCD projection system, the VPL-EX175, VPL-EX145, and VPL-EX120 offer high picture quality and brightness.

3LCD Projection Offers Brilliant Color Performance

The VPL-E Series adopts a 3LCD projection system incorporating three LCD panels. This system enables each projector to present bright and natural images.

12-bit 3D Gamma Correction

The VPL-E Series incorporates 12-bit 3D Gamma Correction circuitry to perform highly accurate gamma correction, achieving smoother gradations and a richer gray scale.

I/P Conversion and Film Mode

The video signal processing technology that Sony has incorporated in the VPL-E Series offers I/P conversion and 2-3 pull-down to generate high-quality images with outstanding clarity.

XGA Resolution

XGA resolution of 1024 x 768 contains 60% more pixels compared to SVGA resolution of 800 x 600. As a result, XGA resolution delivers much greater detail and finer images.

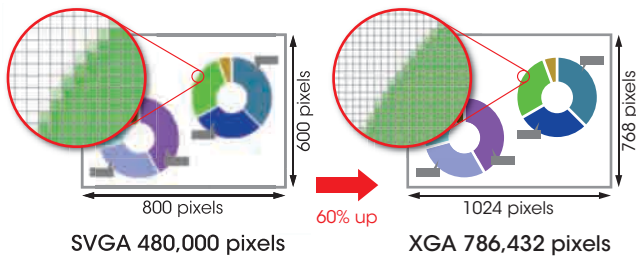

Easy-to-use Functions

Image Freeze

The Image Freeze function can display a freeze frame to allow the presenter to prepare or switch to the next image.

DIMENSIONS

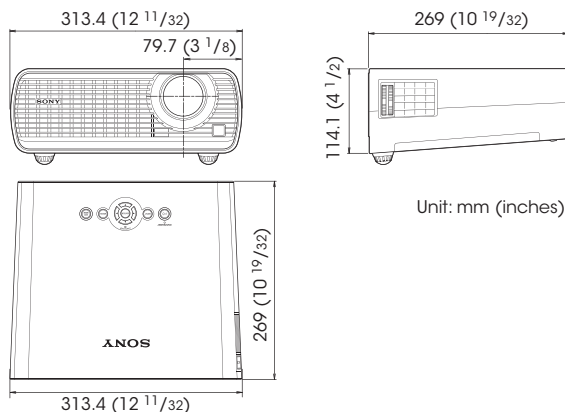

Off and Go

Once a presentation is complete, a VPL-E Series projector can be immediately moved to the next location, simply by turning it off and unplugging the AC power cord - there's no need to wait for the fan to stop.

Front Exhaust

Users can run an optimum presentation even in a quiet environment, and participants seated to the side of the projector are not bothered by hot air and noise.

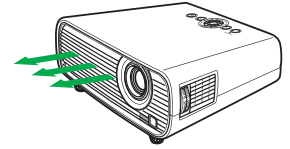

Unique Functional Design

Other Features

Auto Keystone Adjustment

Corrects any trapezoidal distortion automatically

Picture (Audio) Muting

Mutes the image/audio

6 Picture Modes

Selectable six picture modes according to the picture source

Security Pack

Security lock (password and mechanical), security bar, and panel key lock

Direct Power On/Off

Direct power control using a circuit breaker on the switch board

High Altitude Mode

For reliable projector operation at high altitude

Closed Captioning

Official teletext broadcasting, developed by the NCI, USA

Network and Control

Controls and monitors projector status
Compatible with various control systems



OPTIONAL ACCESSORY



LMP-E211

Projector Lamp (for replacement)

CONNECTOR PANELS

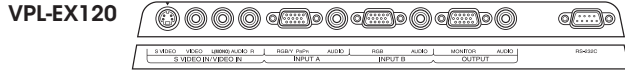
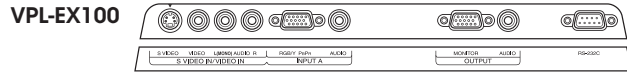
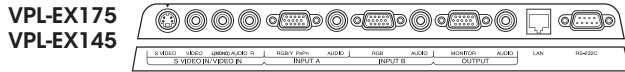

SPECIFICATIONS

	VPL-EX175	VPL-EX145	VPL-EX120	VPL-EX100
Display system	3 LCD system			
Display device	Size of effective display area 0.63" (16.0 mm) x 3, BrightEra, Aspect ratio: 4:3			0.63" (16.0 mm) x 3, Aspect ratio: 4:3
	Number of pixels 2,359,296 (1024 x 768 x 3) pixels			
Projection lens	Zoom Manual (Approx. 1.3 x)			
	Focus Manual			
Light source	High-pressure mercury lamp 210 W type			
Recommended lamp replacement time*1	3000 H / 4500 H / 6000 H (Lamp mode: High / Standard / Low)			
Filter cleaning cycle	Max. 6000 H*1 / Same time as the lamp replacement is recommended			
Screen size	30" to 300" (0.762 m to 7.62 m)*2			
Light output (Lamp mode: High / Standard / Low)	3600 lm / 2700 lm / 2200 lm	3100 lm / 2500 lm / 2000 lm	2600 lm / 2100 lm / 1700 lm	2300 lm / 1800 lm / 1500 lm
Color light output	3600 lm / 2700 lm / 2200 lm	3100 lm / 2500 lm / 2000 lm	2600 lm / 2100 lm / 1700 lm	2300 lm / 1800 lm / 1500 lm
Contrast ratio (full white / full black)*3	4000:1	4000:1	2500:1	2200:1
Speaker	10 W x 1 (monaural)		1 W x 1 (monaural)	
Displayable scanning frequency	Horizontal 14 kHz to 93 kHz			
	Vertical 47 Hz to 93 Hz			
Display resolution	Computer signal input Maximum input signal resolution: 1600 x 1200 (resizing display), Panel display resolution: 1024 x 768 pixels			
	Video signal input NTSC, PAL, SECAM, 480/60i, 576/50i, 480/60p, 576/50p, 720/60p, 720/50p, 1080/60i, 1080/50i			
Color system	NTSC3.58, PAL, SECAM, NTSC4.43, PAL-M, PAL-N, PAL60			
Keystone correction	Vertical: Max. +/- 30 degrees*4			
OSD language	20-languages (English, Dutch, French, Italian, German, Spanish, Portuguese, Turkish, Polish, Russian, Swedish, Norwegian, Japanese, Simplified Chinese, Traditional Chinese, Korean, Thai, Vietnamese, Arabic, Persian)			
Computer and video signal input/output	INPUT A RGB / Y PB PR input connector: Mini D-sub-15 pin (female), Audio input connector: Stereo mini jack			
	INPUT B RGB input connector: Mini D-sub-15 pin (female), Audio input connector: Stereo mini jack			
	S VIDEO IN S video input connector: Mini DIN-4 pin, Audio input connector: Pin jack (x2) (shared with VIDEO IN)			
	VIDEO IN Video input connector: Pin jack, Audio input connector: Pin jack (x2) (shared with S VIDEO IN)			
	OUTPUT Monitor output connector*5: Mini D-sub-15 pin (female), Audio output connector*6: Stereo mini jack (variable out)			
Other signal input/output	RS-232C connector: D-sub 9-pin (female)			
	LAN connector: RJ45, 10BASE-T/100BASE-TX		-	
Operating temperature (Operating humidity)	0°C to 40°C / 32°F to 104°F (35% to 85% (no condensation))			
Storage temperature (Storage humidity)	-20°C to +60°C / -4°F to +140°F (10% to 90%)			
Power requirements	AC 100 V to 240 V, 3.3 A to 1.3 A, 50 Hz / 60 Hz			
Power consumption	AC 100 V to 120 V 320 W / 275 W / 245 W		300 W / 265 W / 235 W	
	AC 220 V to 240 V 310 W / 265 W / 235 W		290 W / 255 W / 225 W	
Standby mode power consumption	AC 100 V to 120 V 9 W / <1.0 W (Standby mode: Standard / Low)		8 W / <1.0 W (Standby mode: Standard / Low)	
	AC 220 V to 240 V 11 W / <1.0 W (Standby mode: Standard / Low)		10 W / <1.0 W (Standby mode: Standard / Low)	
Heat dissipation	AC 100 V to 120 V 1091 BTU		1023 BTU	
	AC 220 V to 240 V 1057 BTU		989 BTU	
Standard outside dimensions	W 313.4 x H 129.6 x D 278.3 mm (W 12 11/32 x H 5 3/32 x D 10 31/32 in)			
	W 313.4 x H 114.1 x D 269 mm (W 12 11/32 x H 4 1/2 x D 10 19/32 in) (without protrusion)			
Mass	3.3 kg / 7 lb 4.4 oz		3.2 kg / 7 lb 0.88 oz	
Supplied accessories	RM-PJ7 Remote Commander (1), Lithium Battery: CR2025 (1), Mini D-sub 15 pin cable (1), Lens Cap (1), Operating Instructions (1), Quick Reference Manual (1), AC power cord (1)			
	-		Carrying case (1)	

*1: The figures are expected maintenance time and not guaranteed. They will depend on the environment or how the projector is used. *2: Viewable area, measured diagonally. *3: The value is average. *4: Depend on resolution. *5: From INPUT A and INPUT B. *6: Works as audio switcher function. From current channel only. Not available in standby.

Distributed by

©2010 Sony Electronics Asia Pacific Pte. Ltd. All rights reserved. Reproduction in whole or in part without written permission is prohibited. Features and specifications are subject to change without notice. The values for mass and dimension are approximate. "SONY" and "make.believe", "BrightEra" and "Remote Commander" are trademarks of Sony Corporation. Trademark PJLink is a trademark applied for trademark rights in Japan, the United States of America and other countries and areas. All other trademarks are the property of their respective owners.

pro.sony-asia.com/projector