

JVC[®]

The Perfect Experience / —

DLA-HD750/DLA-HD350

Full HD D-ILA Home Theatre Front Projector

D-ILA[®]





The remarkable performance of JVC's D-ILA front projectors transforms ordinary home cinema into an extraordinary experience!



For those who demand the best and will accept no less than vivid, real-to-life home cinema entertainment, JVC is proud to introduce two new D-ILA front projectors. Promising exceptional contrast, immaculate colour rendition, and remarkably clear images, the DLA-HD750 and DLA-HD350 models look good too — sporting a stylish yet highly functional cabinet design with either a black or white* finish. See is believing, so be the first to experience the breathtaking picture quality that these new D-ILA front projectors have to offer and watch your world of home cinema come alive.

** White available only for the DLA-HD350.*



D-ILA®



DLA-HD750/350

Full HD D-ILA Home Theatre Front Projector

◆ The industry's highest* native contrast ratio of 50,000:1!

Changing the structural design of the optical section from a conventional L-shape to a straight configuration helped to reduce light leakage and by combining this new structure with a highly efficient lamp, a brightness of 900 lumens* was realised. What's more, integrating JVC's proprietary D-ILA device with the wire-grid optical engine provided very high contrast. And, by equipping the newly developed lens with a fixed aperture to help eliminate unnecessary light that reduces contrast levels, it was possible for the DLA-HD750 to achieve the industry's highest native contrast ratio of 50,000:1**.

Thanks to enhanced brightness created by the extended white peak as well as the wider dynamic range for a deeper black, images are vivid and full of depth, making them perfectly suited for all types of content, including movies, music video as well as live concert and sports programs.

* 1000 lumens for the DLA-HD350.
 **As of July 2008; native contrast of 50,000:1 for home theatre projector class (JVC survey).
 Native contrast ratio of 30,000:1 for the DLA-HD350.

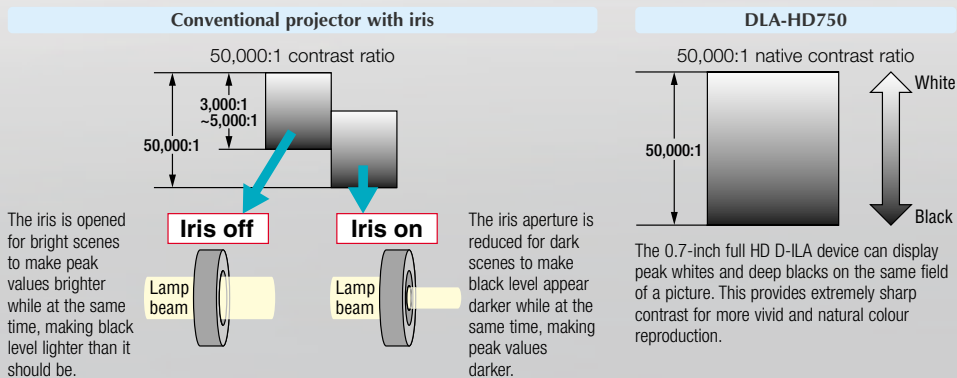
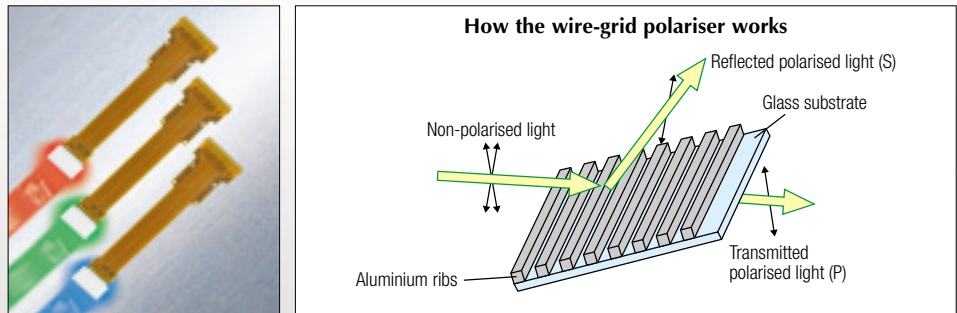
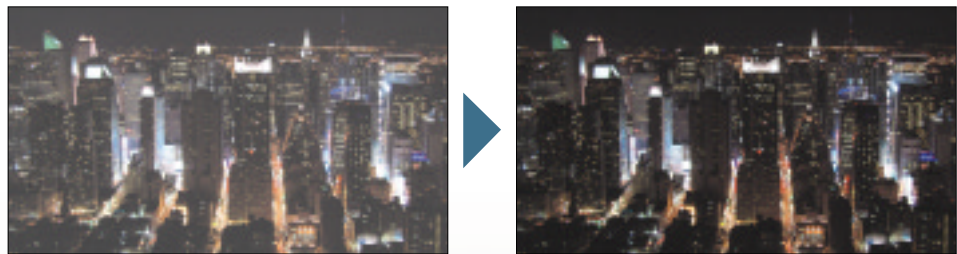

◆ High-performance 2x motorised zoom lens

The newly developed high-performance 2x zoom lens with motorised focus features a large diameter, all-glass lens system with 17 elements in 15 groups that includes 2 ED lenses to project a full HD image with exceptional depth. And to display the deepest black possible, this new high-precision lens is also equipped with a 16-step* lens aperture that allows adjustment of brightness according to user preferences and usage environment. What's more, the high-precision lens also reduces chromatic aberration and colour bleeding significantly.

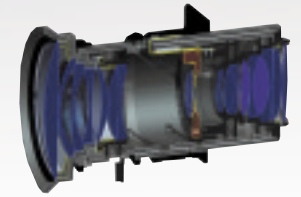

* 3-step for the DLA-HD350.

◆ Excellent colour rendition

The DLA-HD750 features Colour Management that interpolates colours individually by R, G, B, C, Y, or M, in three separate axes of colour phase, chroma saturation, and brightness. Up to three customised colour settings can be stored for future use.



◆ Customised gamma control on-screen

Manual adjustment of gamma curve is possible via an on-screen display, allowing the viewer to adjust projector luminance levels by either increasing contrast in scenes that are too dark or dimming washed-out scenes to ensure precise brightness levels suited to individual preferences. Up to three settings can be adjusted and stored for future use.



◆ Advanced video processor

Both projectors incorporate the HQV Reon-VX video processor developed by Silicon Optix. To ensure excellent image reproduction, this processor features precision I/P conversion and scaling with full 10-bit 4:4:4 signal processing as well as an HQV noise reduction function to block mosquito noise.



◆ THX Certified Display (DLA-HD750)



The DLA-HD750 has passed the THX Certified Display program, which is a performance benchmark for high definition (HD) displays that will enable JVC's original D-ILA to deliver the sharpest and most detailed images possible. A number of criteria for home theatre display products such as luminance, gamut and colours, grey scale, contrast, etc. have been established by THX Certified Display program, to ensure the exceptional display performance that home theatre fans are looking for.

◆ Flexible and easy set-up

Setting up is easier than ever before as the $\pm 80\%$ vertical and $\pm 34\%$ horizontal lens shift function is now electrically operated, allowing the projected picture to be moved horizontally or vertically effortlessly via the remote controller. What's more, the 2x motorised zoom lens — with throw distances of 3.1 metres to 6.2 metres for the 100-inch display — makes tedious magnification or focus adjustment easy thanks to its high-performance motor.

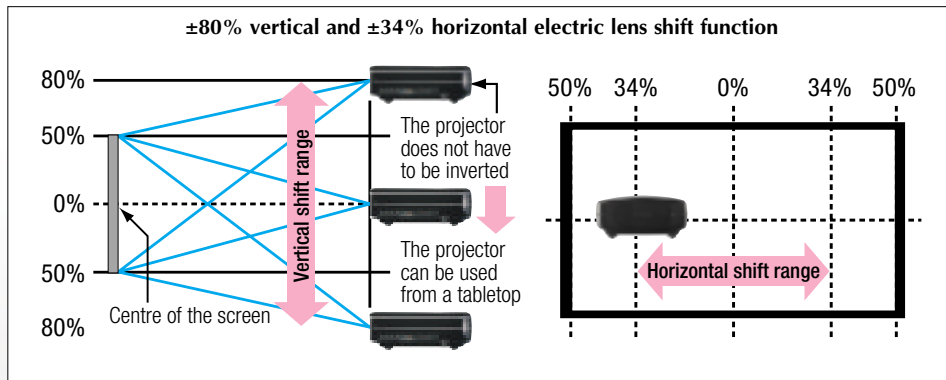

The vertical and horizontal lens shift function cannot be set to the maximum values simultaneously.

And when positioning the projector outside of the lens shift coverage area, the Digital Keystone function with $\pm 30^\circ$ vertical and $\pm 40^\circ$ horizontal adjustment helps to make distorted images look more natural.

Also featured is a unique automatic lens cover that opens and closes with power on/off to protect against dust, so even if the projector is installed up on the ceiling, you're assured of easy, trouble-free operation via the remote controller.



Lens cover closed



Lens cover open

◆ Self-illuminating remote control

The buttons on the handy self-illuminating remote control light up automatically, making it easy to operate even in a dark room.

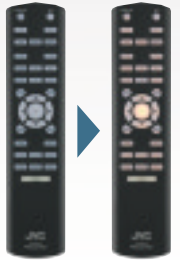

◆ Terminal for trigger functions (DLA-HD750)

The DLA-HD750 features a terminal that can be used for two trigger functions. Screen trigger will automatically move the screen up and down with power on/off control while the Anamorphic Lens trigger (DLA-HD750) will automatically move the anamorphic lens to stretch the screen to the 2.35:1 aspect ratio with V-stretch mode on/off.

◆ HDMI interface

Both projectors feature two HDMI interfaces with CEC compatibility.



◆ Quiet operation

Thanks to the enhanced efficiency of the cooling system, fan noise has been reduced to 20dB*, enabling the viewer to better concentrate on what's being shown on the screen even in a very quiet room.

** When lamp mode set to standard mode.*





DLA-HD750BE

Full HD D-ILA front projector with 50,000:1 native contrast ratio, three D-ILA devices, 2x motorised zoom lens with motorised focus, HQV Reon-VX video processor, Colour Management, on-screen gamma control, flexible set-up and much more.



[Basic Features]

- Three 0.7" Full HD D-ILA devices
- Input signal capability: 1080p
- True full HD resolution: 1920 x 1080p
- 200W UHP (ultra high-pressure mercury) lamp
- Projection Size: 60-inch to 200-inch
- Projection Distance: 3.01m to 6.08m (100-inch)
- Terminals: RS232C x 1, HDMI x 2 (v.1.3), Component x 1, S-Video x 1, Composite x 1, PC x 1, and Trigger x 1

[Product Highlights]

- Industry's highest 50,000:1 native contrast ratio* realized by the combination of enhanced full HD D-ILA devices and optical engine
- THX Certified Display model
- Colour Management with R, G, B, C, Y or M colour interpolation; up to three customised colour settings can be stored
- On-screen user-customisable gamma control
- High-performance 2x zoom lens with motorised focus featuring a large diameter all-glass lens system with 17 elements in 15 groups including 2 ED lenses
- V-stretch mode together with the anamorphic lens allows for the display of images without top and bottom black bars
- Digital Keystone enables easy adjustment of distorted images

*As of July 2008; Native contrast ratio of 50,000:1 for home theatre projector class (JVC internal survey).



DLA-HD350BE DLA-HD350WE

Full HD D-ILA front projector with 30,000:1 native contrast ratio, three D-ILA devices, 2x motorised zoom lens with motorised focus, HQV Reon-VX video processor, on-screen gamma control, flexible set-up and much more.



[Basic Features]

- Three 0.7" Full HD D-ILA devices
- Input signal capability: 1080p
- True full HD resolution: 1920 x 1080p
- 200W UHP (ultra high-pressure mercury) lamp
- Projection Size: 60-inch to 200-inch
- Projection Distance: 3.01m to 6.08m (100-inch)
- Terminals: RS232C x 1, HDMI x 2 (v.1.3), Component x 1, S-Video x 1, Composite x 1

[Product Highlights]

- 30,000:1 native contrast ratio realized by the combination of enhanced full HD D-ILA devices and optical engine
- On-screen user-customisable gamma control
- High-performance 2x zoom lens with motorised focus featuring a large diameter all-glass lens system with 17 elements in 15 groups including 2 ED lenses
- V-stretch mode together with the anamorphic lens allows for the display of images without top and bottom black bars
- Digital Keystone enables easy adjustment of distorted images
- Available in black or white finish

Projection Distance Chart

Inch	Display size (16:9)		Projection distance	
	W (mm)	H (mm)	Wide (m)	Tele (m)
60	1,328	747	1.78	3.63
70	1,549	872	2.09	4.24
80	1,771	996	2.40	4.86
90	1,992	1,121	2.71	5.47
100	2,214	1,245	3.01	6.08
110	2,435	1,370	3.32	6.70
120	2,656	1,494	3.63	7.31
130	2,878	1,619	3.93	7.93
140	3,099	1,743	4.24	8.54
150	3,320	1,868	4.55	9.16
160	3,542	1,992	4.86	9.77
170	3,763	2,117	5.16	10.38
180	3,984	2,241	5.47	11.00
190	4,206	2,366	5.78	11.61
200	4,427	2,490	6.08	12.23

*Projection distances are design specifications, so there is ±5% variation.

Specifications

	DLA-HD350	DLA-HD750
Device	0.7inch D-ILA x3	
Resolution	1920 x 1080 pixels	
Lens	2x motorised zoom & focus f=21.4mm - 42.8mm F=3.2 - 4	
Lens shift	±80% Vertical / ±34% Horizontal (motorised)	
Projection size	60 - 200 inches	
Light source lamp	200W UHP	
Brightness	1,000lm	900lm
Contrast ratio	Native:30,000:1	Native:50,000:1
Terminals	HDMI (ver.1.3) x2 Component x1 (RCA) S-Video x1 (mini DIN) Composite x1 (RCA) RS-232C (D-sub 9-pin)	HDMI (ver.1.3) x2 Component x1 (RCA) S-Video x1 (mini DIN) Composite x1 (RCA) PC x1 (D-Sub 15-pin) Trigger x1 (mini jack) RS-232C (D-sub 9-pin)
Video input signal	480i/p, 576i/p, 720p 60/50, 1080i 60/50, 1080p 60/50/24	
PC input signal	Digital	VGA/SVGA/XGA/WXGA+WXGA+/SXGA/WXGA+/WUXGA
	Analogue	-
Noise level	19dB (Normal mode)	
Power requirement	AC 110V-240V, 50/60 Hz	
Power consumption	280W (Stand-by mode:1W)	
Dimensions (W x H x D)	365 x 167 x 478 mm 14 3/8 x 6 5/8 x 18 7/8 inches	
Weight	11.0kg 24.3 lbs	

External dimensions

■ Top

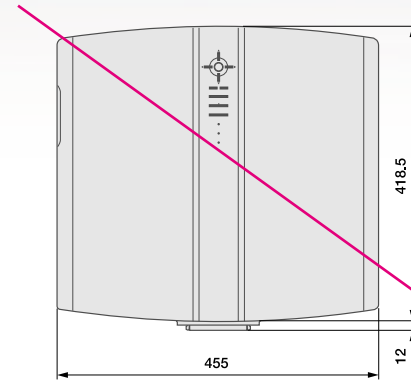

■ Bottom

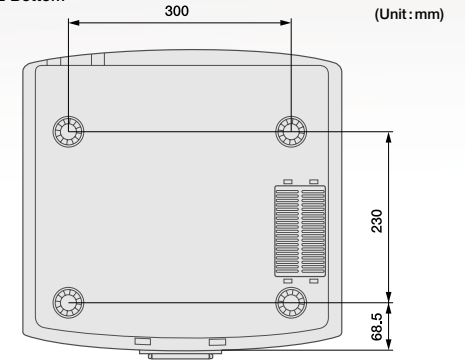

■ Front

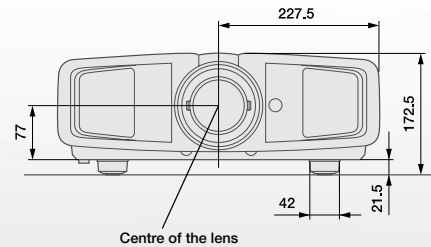

■ Side (left)

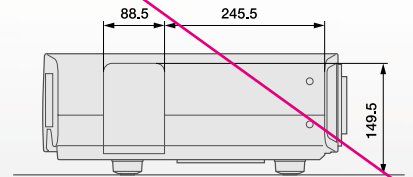

Terminals on the side



Optional Accessory



User-replaceable Lamp
BHL5010-S



- The projector is equipped with a high-pressure mercury lamp, which may break, emitting a loud noise, when it is subjected to shock or after it has been used for some length of time.
- Please note that, depending on how the projector is used, there can be considerable difference between individual lamps regarding how many hours they will operate before requiring replacement.
- An additional payment is required for installation of a new lamp, if necessary.
- The projector lamp requires periodic replacement and is not covered by warranty.
- Please be aware that, because the D-ILA device is manufactured using highly advanced technologies, 0.01% or fewer of the pixels may be non-performing (always on or off).

All pictures on this brochure are simulated. HDMI, the HDMI logo and High-Definition Multimedia Interface are trademarks or registered trademarks of HDMI Licensing LLC. All other brand or product names may be trademarks and/or registered trademarks of their respective owners. Any rights not expressly granted herein are reserved.

Copyright © 2008, Victor Company of Japan, Limited (JVC). All Rights Reserved.

JVC[®]

DISTRIBUTED BY

JVC
JAZZ
FESTIVAL

www.jvc-europe.com
www.jvc-asia.com

Printed in Japan
CCN-XXXX-08